

# **Radiation and Gas**

Amount of outgoing radiation energy passing per second along a bundle of light rays from a small area of the emitting body ...

In stellar photosphere, with a spherical symmetry, the intensity at a position is a function of  $x$  from the stellar surface, in the direction of angle  $\theta$ , and normal to the gas layer.

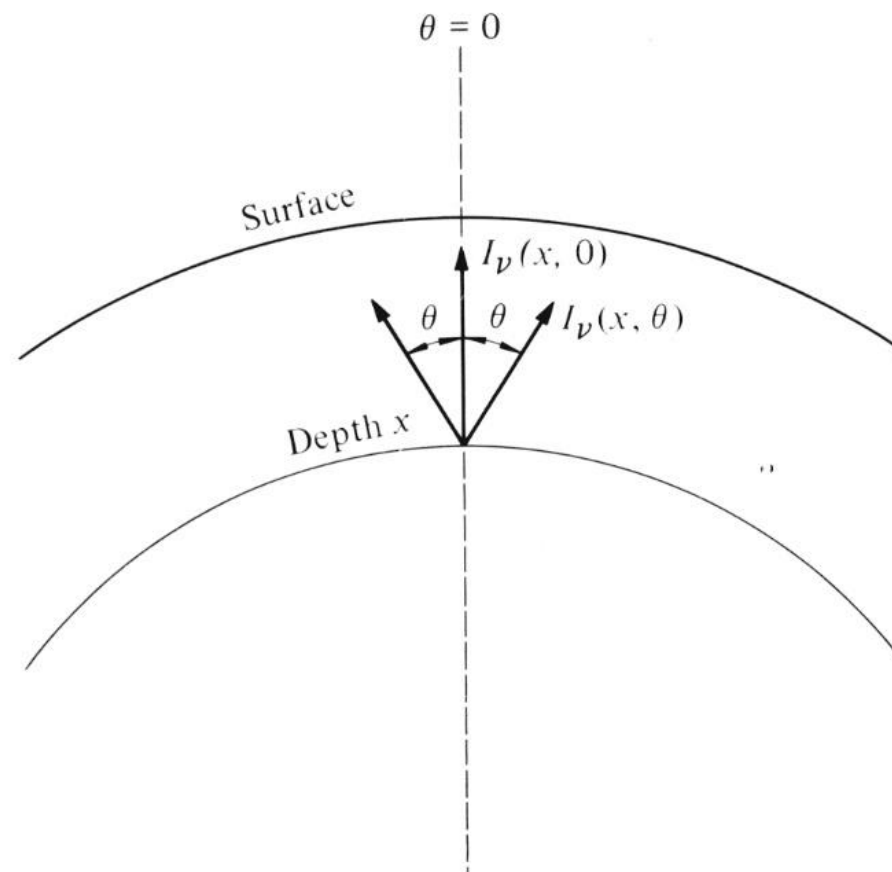

Radiation of frequency between  $\nu$  and  $\Delta\nu$  at point  $P$  normal to the small area  $\Delta\sigma$  in the direction around  $PP'$



Radiation from each point of the area  $\Delta\sigma$  into the solid angle  $\Delta\omega$  about  $PP'$

Envelope of the cones for a circular area  $\Delta\sigma$

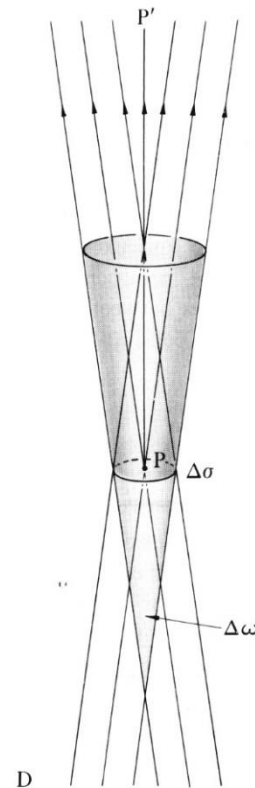
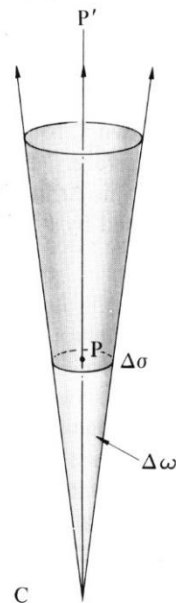

Bundles of radiation rays passing through  $\Delta\sigma$  into the solid angle  $\Delta\omega$  about  $PP'$

**Specific Intensity**  $I_\nu$  or simply “intensity”, or “brightness”, is the amount of radiation energy per unit frequency interval at  $\nu$  per unit time interval per unit area per unit solid angle passing into the specified direction at a position  $P$ .

$$I_\nu(\theta) = \lim_{\substack{\Delta\nu \rightarrow 0 \\ \Delta t \rightarrow 0 \\ \Delta\sigma \rightarrow 0 \\ \Delta\omega \rightarrow 0}} \frac{\Delta E_\nu}{\Delta\nu \Delta t \Delta\sigma \Delta\omega \cos\theta}$$

In cgs unit,  $I_\nu$  [ergs s<sup>-1</sup> cm<sup>-2</sup> sr<sup>-1</sup> Hz<sup>-1</sup>]

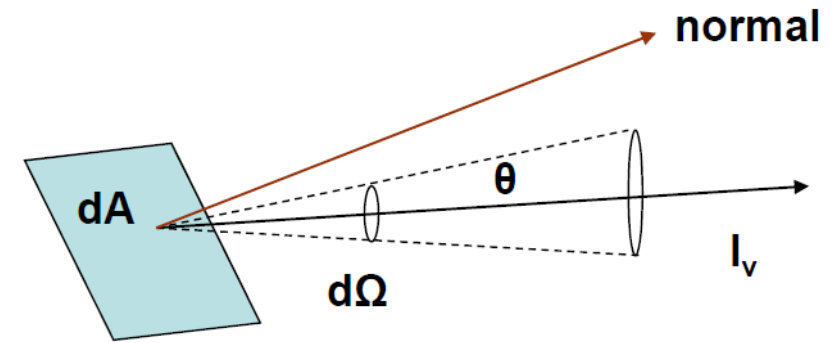

Because  $\Delta\omega \rightarrow 0$ , the energy does not diverge. The intensity is independent of the distance from the source (i.e., light ray).

## Planar angle

radian

## Solid angle

steradian (stereo+radian)

$[\text{area}/\text{radius}^2] = \text{m}^2/\text{m}^2$ , dimensionless

The entire sky =  $4\pi$

$$1 \text{ sr} = \text{rad}^2 = \frac{A}{r^2} \text{ sr} = 41253/4\pi = 3283 \text{ deg}^2$$

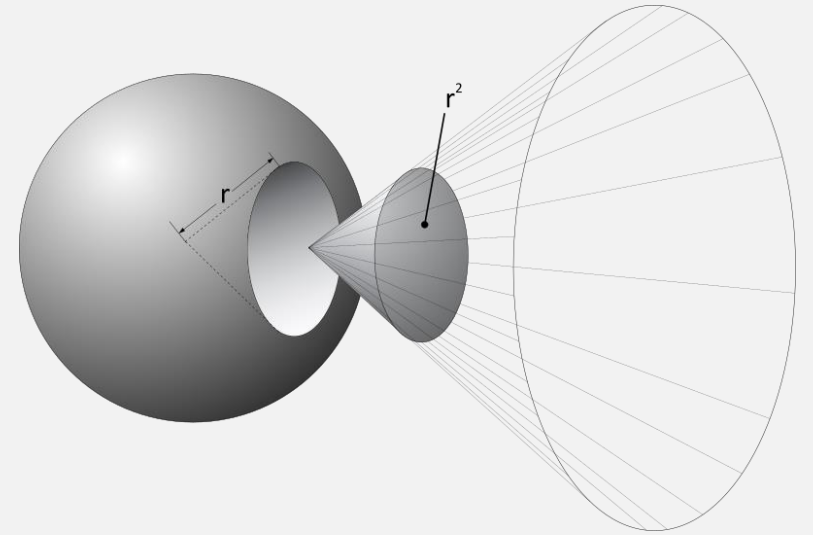

In general, the outward or inward radiation flux passing through  $\Delta\sigma$  in the direction  $\theta$  (projection) is

$$F_{\nu}^{+}(x) = \int_{\text{hemisphere}}^{\text{outward}} I_{\nu}(x, \theta) \cos \theta \, d\omega, \theta = 0, \pi/2$$

or

$$F_{\nu}^{-}(x) = - \int_{\text{hemisphere}}^{\text{inward}} I_{\nu}(x, \theta) \cos \theta \, d\omega, \theta = \pi/2 \text{ to } \pi$$

So the net flux is  $F_{\nu}^{+}(x) - F_{\nu}^{-}(x) = \int_{\text{sphere}} I_{\nu}(x, \theta) \cos \theta \, d\omega$

Outward flux diminishes with increasing distance from the source, because the maximum solid angle decreases.

In the sphere,  $\frac{d\omega}{4\pi} = \frac{dA}{4\pi r^2} \rightarrow d\omega = \frac{dA}{r^2}$

But  $dA = (r d\theta) (r \sin \theta d\varphi)$ , so  
 $d\omega = \sin \theta d\theta d\varphi$

An integral over a sphere is then

$$\int_{\varphi=0}^{2\pi} \int_{\theta=0}^{\pi} \dots d\theta d\varphi$$

So the outward flux is, for a uniform  $I_\nu$ ,

$$\begin{aligned} F_\nu^+(x) &= \int_{\text{hemisphere}} I_\nu(x, \theta) \cos \theta d\omega \\ &= I_\nu \int_{\varphi=0}^{2\pi} \int_{\theta=0}^{\pi/2} \cos \theta \sin \theta d\theta d\varphi = 2\pi I_\nu \left[ \frac{1}{2} \sin^2 \theta \right]_0^{\pi/2} \\ &= \pi I_\nu \end{aligned}$$

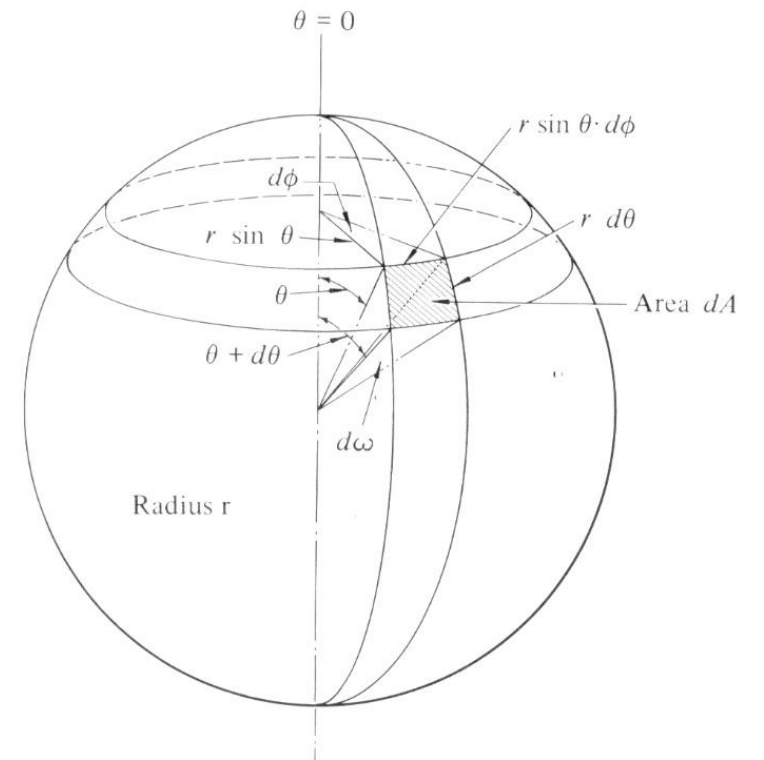

$$dE_\nu = I_\nu dv dt d\sigma d\omega \cos \theta \quad I_\nu = I_\nu(x, y, z, \theta, \phi)$$

## Mean Intensity

$$J_\nu = \frac{1}{4\pi} \int I_\nu(\theta, \phi) d\omega = \frac{1}{4\pi} \int_{\theta=0}^{\pi} \int_{\phi=0}^{2\pi} I_\nu(\theta, \phi) \sin \theta d\theta d\phi$$

## Total Radiation

$$I = \int_0^\infty I_\nu dv$$

## Flux

$$F_\nu = \int I_\nu \cos \theta d\omega \text{ [ergs s}^{-1}\text{cm}^{-2}\text{ Hz}^{-1}\text{]} \quad \text{Total Flux } F = \int F_\nu dv$$

## Energy Density

$$u_\nu = \frac{1}{c} \int I_\nu d\omega = \frac{4\pi}{c} J_\nu \text{ [ergs cm}^{-3}\text{ Hz}^{-1}\text{]}$$

## Total Energy Density

$$u = \int u_\nu dv = aT^4 \quad a = 4\sigma_B/c$$

## Entropy

$$S = \frac{4}{3} a T^3 V$$



- A star → **a point source**  
→ flux/magnitude  
e.g.,  $m_V=15.7$  mag
- A galaxy or the central part of a globular cluster  
→ **an extended source**  
→ integrated flux, or surface brightness  
e.g., 18.2 mag/sq arcsec
- The sky is an extended source.  
In a dark site, sky~20-21 mag/sq arcsec

- **Intensity**: Flux per solid angle
- **Radiance**: For an extended source; flux per solid angle per projected area
- **Candela** (cd): Intensity/brightness in a specific direction
- **Lumen** (lm): For visible light; luminous flux;  $1 \text{ lm} = 1 \text{ cd} \cdot \text{sr}$ ; e.g., 3000 lm for a room projector
- **Lux** (lx): Illuminance for visible light; lumen per area;  

$$1 \text{ lx} = 1 \text{ lm m}^{-2} = 1 \text{ cd sr m}^{-2} = 10^{\frac{-14.18 - m_V}{2.5}}$$
; e.g., 0 mag =  $2.06 \mu\text{lx}$
- (Spectral) irradiance:  $[\text{W m}^{-2} \text{ nm}^{-1}]$   
 Total solar irradiance =  $1361 \sim 1362 \text{ W m}^{-2}$
- **Jansky**: spectral irradiance;  

$$1 \text{ Jy} = 10^{-26} \text{ W m}^{-2} \text{ Hz}^{-1} = 10^{-26} \text{ kg s}^{-2}$$
;  $1 \mu\text{Jy} = 10^{\frac{23.9 - AB}{2.5}}$
- × Watt: Historically the power assumption of an incandescent lightbulb; no longer used for brightness

## Radiation Pressure

Each quantum of energy,  $E = h\nu$ ,  
associated with a momentum  $h\nu/c$

Radiation pressure  $\rightarrow$  net rate of momentum transfer  
(cf. gas pressure)

Radiation passing per second, through a unit area, at an angle  $\theta$   
with the normal, in a solid angle  $d\omega$ , is  $I \cos \theta d\omega$

$\rightarrow$  Momentum transfer =  $(I \cos \theta d\omega/c) \cos \theta$

$$\therefore P_R = \frac{2}{c} \int I \cos^2 \theta d\omega$$

projection of the area  
normal to the surface

For isotropic radiation,  $P_R = \frac{4\pi I}{3c} = u/3 = aT^4/3$

For a surface of uniform brightness  $B$ ,  $J = B$

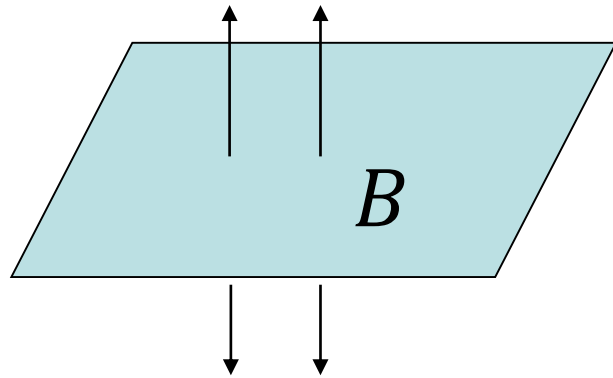

For a sphere of uniform brightness  $B$   
 $\rightarrow$  an isotropic source,  $I = B$

Flux on the surface  $F = \pi B$

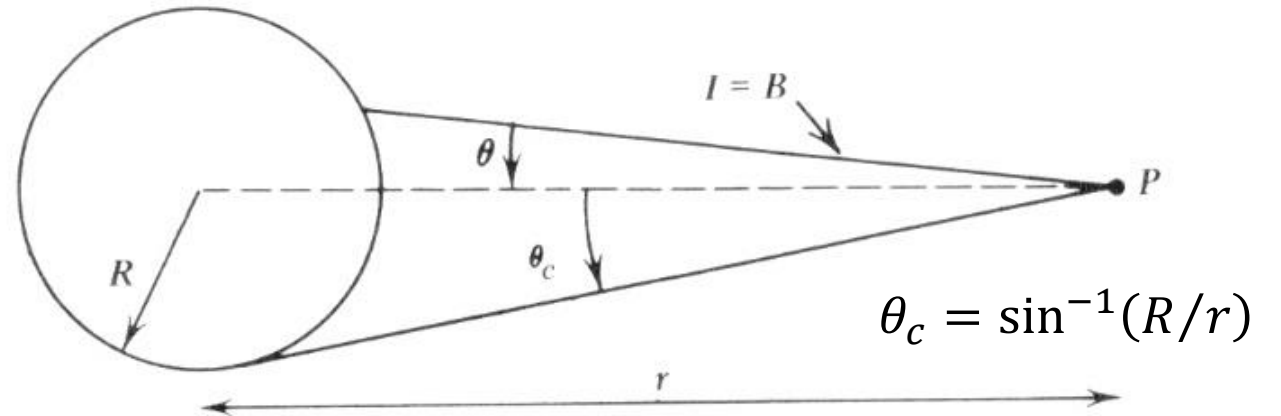

$$\begin{aligned} \text{Recall } F &= \int I_\nu \cos \theta \, d\omega = B \int_0^{2\pi} d\phi \int_0^{\theta_c} \sin \theta \cos \theta \, d\theta \\ &= \pi B (1 - \cos^2 \theta_c) = \pi B \sin^2 \theta_c = \pi B \left(\frac{R}{r}\right)^2 \end{aligned}$$

Letting  $r = R$ ,  $F = \pi B$

# VizieR

- ▶ [Show the target form](#)
- ▶ [Show constraint information](#)

The 3 columns in *color* are computed by VizieR, and are *not part of the original data*.

[II/125/main](#)  
*Post annotation*

[IRAS catalogue of Point Sources, Version 2.0 \(IPAC 1986\)](#)  
IRAS Point Sources (**fluxes in red for upper limits**) (245889 rows)

[1988IRAS](#)

 [start AladinLite](#)

 [plot the output](#)

 [query using TAP/SQL](#)

<i>Full</i>	<i>r</i>	<i>RAJ2000</i>	<i>DEJ2000</i>	<i>IRAS</i>	<i>RA1950</i>	<i>DE1950</i>	<i>Fnu_12</i>	<i>q_</i>	<i>Fnu_25</i>	<i>q_</i>	<i>Fnu_60</i>	<i>q_</i>	<i>Fnu_100</i>	<i>q_</i>	<i>NLRS</i>	<i>NID</i>
	arcmin	"h:m:s"	"d:m:s"		"h:m:s"	"d:m:s"	Jy		Jy		Jy		Jy			
<u>1</u>	0.157	18 36 55.921	+38 46 53.19	18352+3844	18 35 15.1	+38 44 16	4.16e+01	3	1.10e+01	3	9.51e+00	3	7.76e+00	3	<u>3</u>	<u>8</u>

[II/125/assoc](#)  
*Post annotation*

[IRAS catalogue of Point Sources, Version 2.0 \(IPAC 1986\)](#)  
Associations (142228 rows)

[1988IRAS](#)

 [plot the output](#)

 [query using TAP/SQL](#)

[plot the output](#)

 [query using TAP/SQL](#)

ing the VizieR Service  
R data

# Vega SED

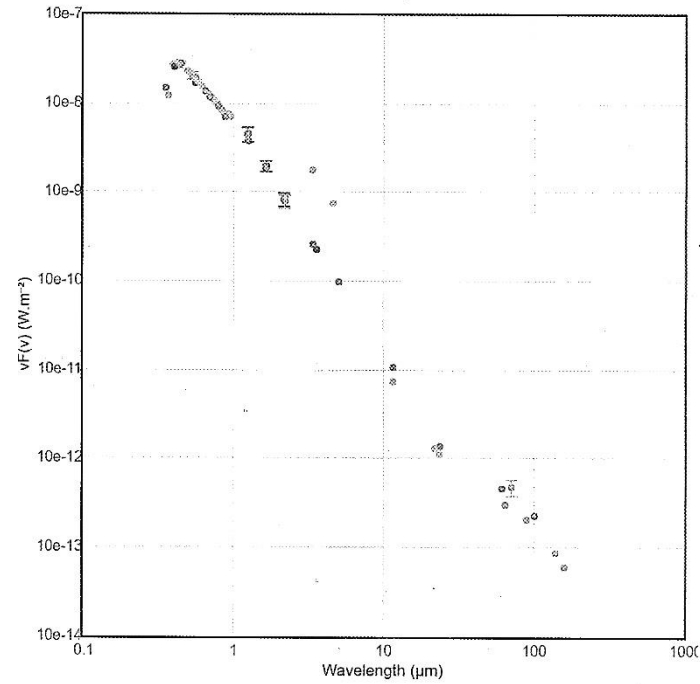
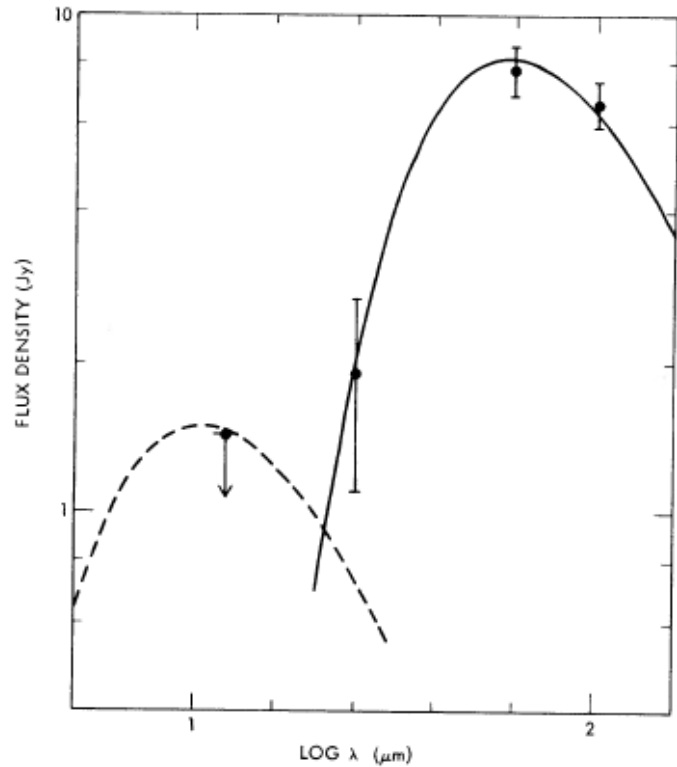
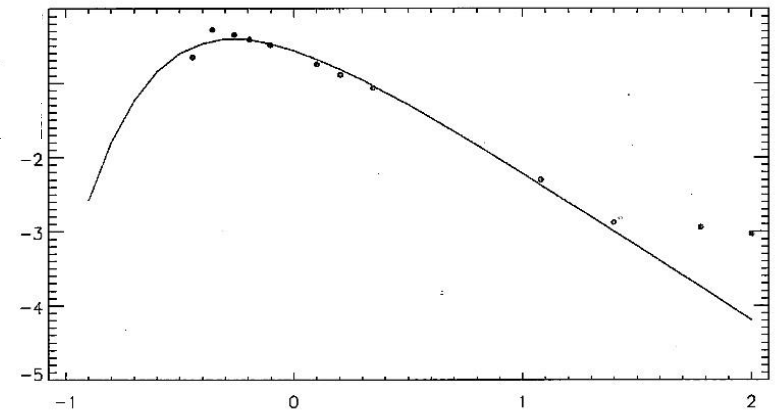

FIG. 1.—Energy distribution of the infrared excess from  $\alpha$  Lyr. The error bars represent the 10% calibration uncertainty. The  $12 \mu\text{m}$  upper limit indicates the effect of the 5% uncertainty in the absolute calibration at  $12 \mu\text{m}$ . The solid line represents a 85 K blackbody spectrum with a solid angle of  $7 \times 10^{-13}$  sr fitted to the excess. The dashed line represents a 500 K blackbody spectrum with a solid angle of  $6.3 \times 10^{-16}$  sr arbitrarily fitted to the  $12 \mu\text{m}$  upper limit.

Aumann+84



# Blackbody Radiation

$$B_\nu(T) d\nu = \frac{2 h \nu^3}{c^2} \frac{1}{e^{h\nu/kT} - 1} d\nu \quad (\text{Planck's law})$$

$$\sigma = \frac{2\pi^5 k^4}{15c^2 h^3}$$

$$a = \frac{4\sigma}{c}$$

Energy density  $u(\nu, T) d\nu = \frac{4\pi}{c} I = \frac{8\pi h}{c^3} \frac{\nu^3}{e^{h\nu/kT} - 1} d\nu$

Total Energy  $u = \int u(\nu, T) d\nu, u = aT^4$  (Stefan-Boltzmann law)

In terms of wavelength,

$$|d\nu| = c \frac{d\lambda}{\lambda^2}$$

$$B_\lambda(T) d\lambda = \frac{2 hc^2}{\lambda^5} \frac{1}{e^{hc/\lambda kT} - 1} d\lambda \quad (\text{Planck's law})$$

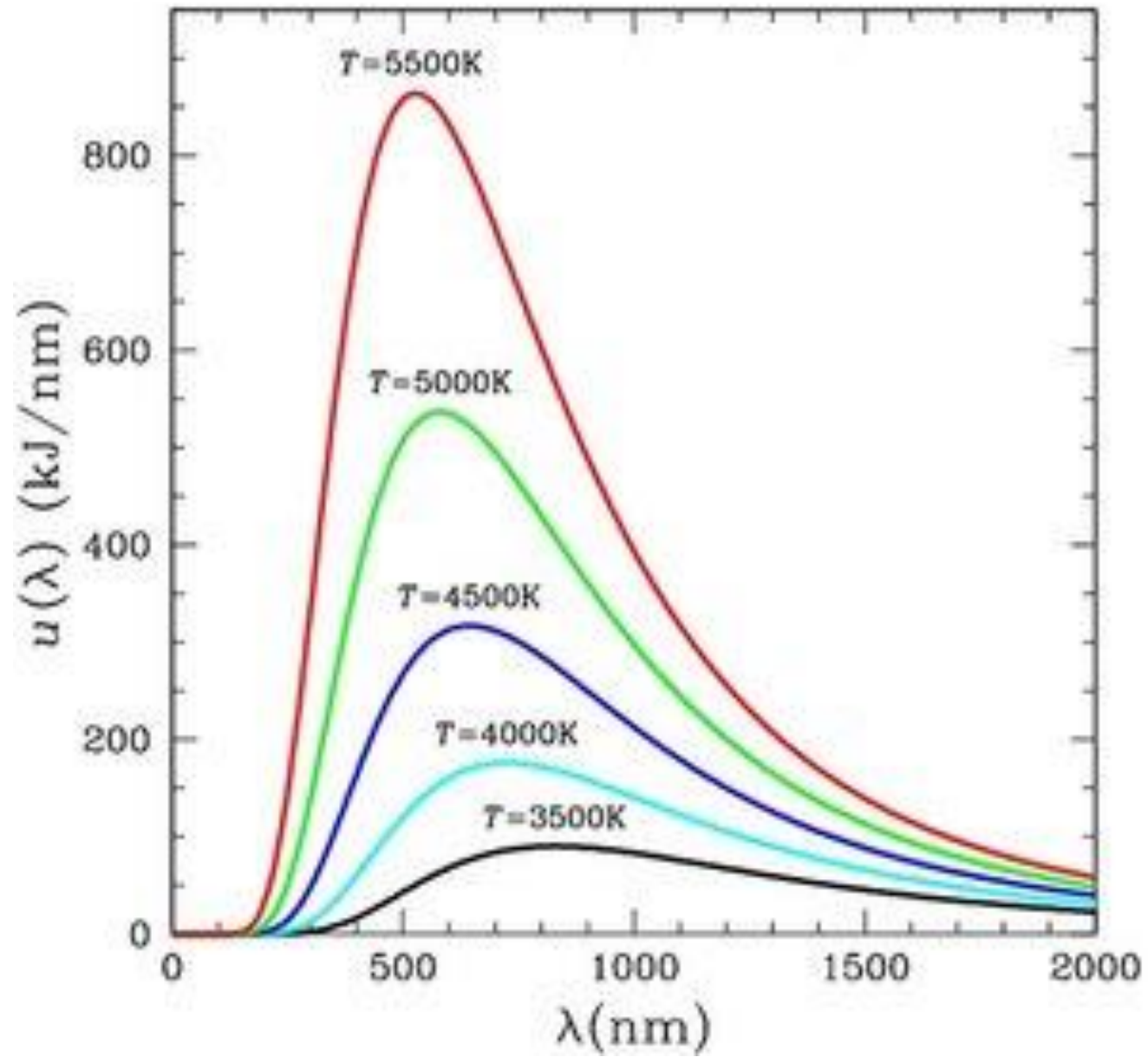



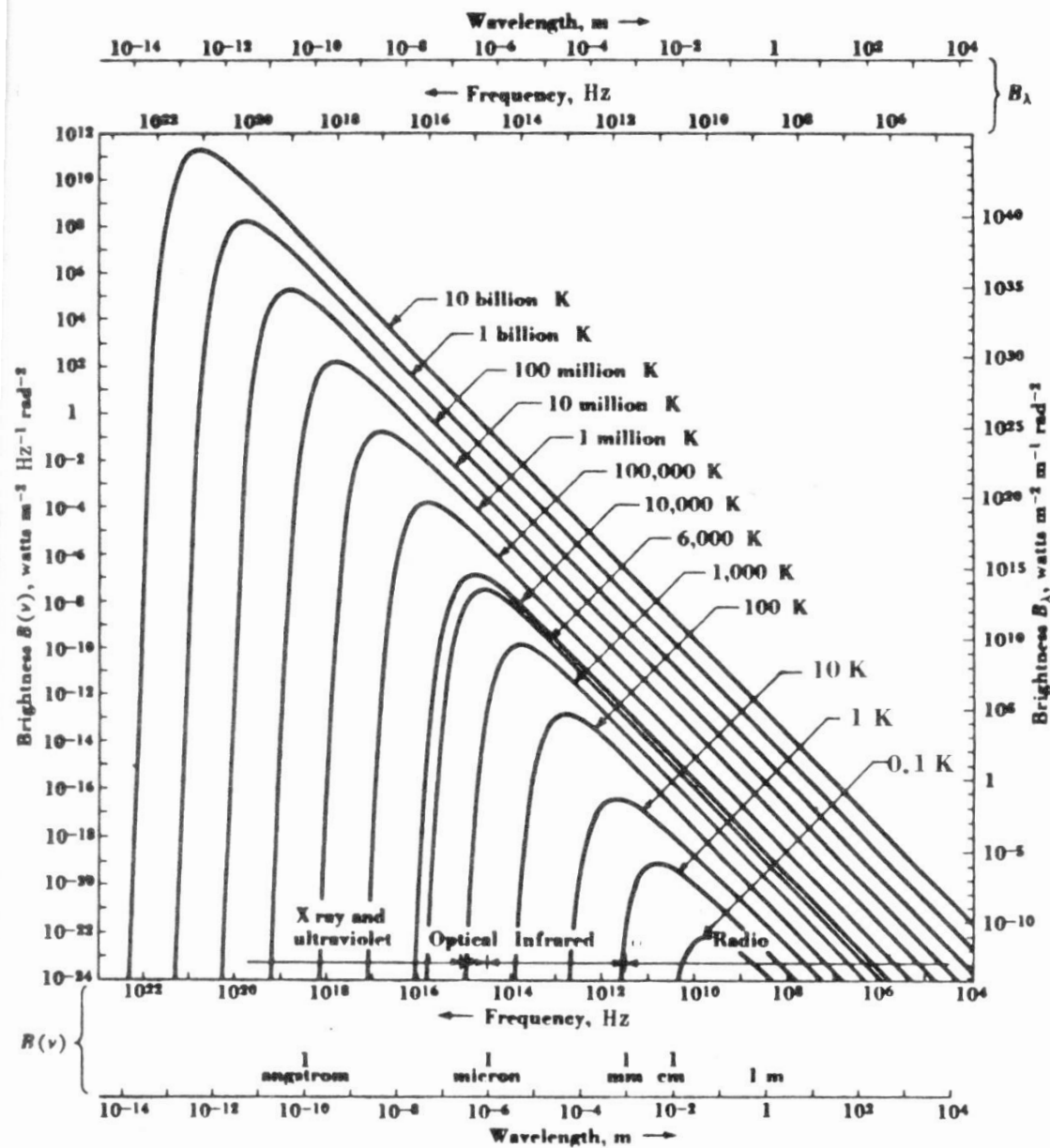

Fig. 3-13. Planck-law radiation curves to logarithmic scales with brightness expressed as a function of frequency  $B(\nu)$  (left and bottom scales) and as a function of wavelength  $B_\lambda$  (right and top scales). Wavelength increases to the right.

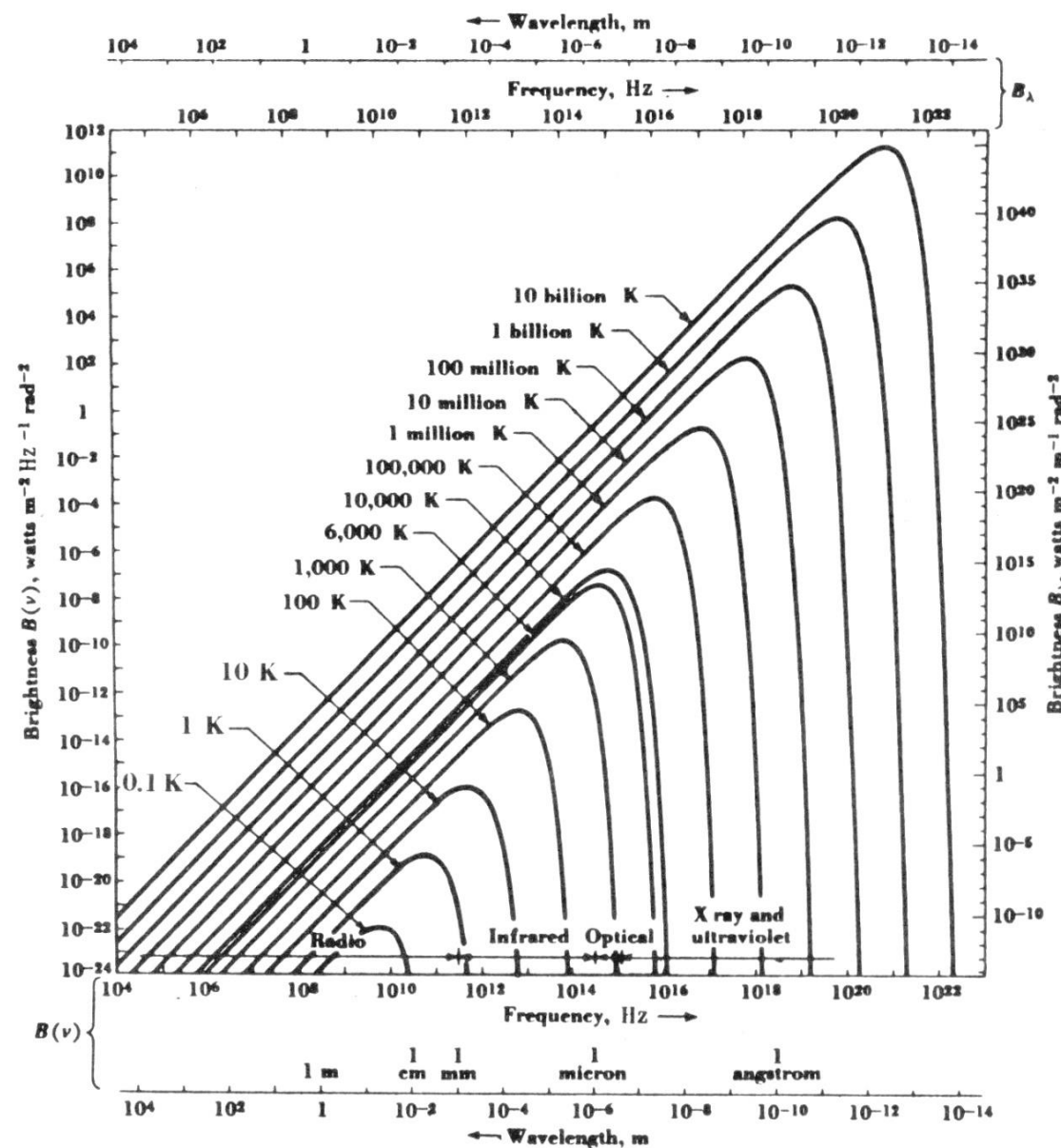

Fig. 3-14. Planck-radiation-law curves with frequency increasing to the right.

\* The usual statement gives the integrated value of  $B'$  over one hemisphere as obtained by multiplying (3-57) by  $\pi$ . See (3-10).

$$\frac{\partial B_\lambda}{\partial \lambda} \Big|_{\lambda=\lambda_{\max}} = 0$$

$$\rightarrow \lambda_{\max} T \approx 2900 \text{ } [\mu\text{m}\cdot\text{K}] \text{ (Wien's displacement law)}$$

Solar photosphere,  $T \sim 6000 \text{ K}$

$$\rightarrow \lambda_{\max} \sim 0.5 \text{ } \mu\text{m} = 5000 \text{ } \text{\AA} = 500 \text{ nm (visible)}$$

Solar corona,  $T \sim 10^6 \text{ K} \rightarrow \lambda_{\max} \sim 3 \times 10^{-3} \text{ } \mu\text{m} = 3 \text{ nm (X rays)}$

Dark clouds,  $T \sim 20 \text{ K} \rightarrow \lambda_{\max} \sim 150 \text{ } \mu\text{m} \text{ (FIR)}$

Note  $\lambda_{\max} \nu_{\max} \neq c$

$$\frac{\nu_{\max}}{T} \approx 5.88 \times 10^{10} \text{ } [\text{Hz K}^{-1}] \text{ (Wien's displacement law)}$$

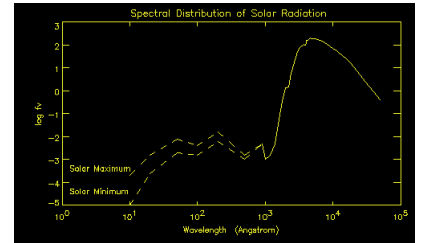

When  $\underline{h\nu/kT \gg 1}$

$$B_\nu(T) d\nu \approx \frac{2 h\nu^3}{c^2} e^{-h\nu/kT} d\nu \quad \text{(Wien approximation)}$$

---

When  $\underline{h\nu/kT \ll 1}$ , (low freq. or high temperature, valid in all radio regimes in astronomical situations)

$$B_\nu(T) d\nu \approx \frac{2 h\nu^3}{c^2} \frac{kT}{h\nu} d\nu = \frac{2kT}{c^2} \nu^2 d\nu = \frac{2kT}{\lambda^2} d\nu \quad e^x \approx 1+x+\dots$$

“UV (Rayleigh-Jeans) catastrophe” (Rayleigh-Jeans approximation)

Because  $B_\nu \propto T$ , in radio astronomy  $\rightarrow$  brightness temperature  
Also antenna temperature, noise temperature ... even if the radiation is not thermal.

## Brightness Temperature $I_\nu \equiv B_\nu(T_B)$

The temperature with which, at a certain frequency, the intensity of a source equals to that of the blackbody.  $T_B(\nu)$  is a nonlinear function of intensity.

$$T_B(\nu) \equiv \frac{h\nu k}{\log(1 + 2h^3/c^2 I_\nu)}$$

In the Rayleigh-Jeans regime, i.e., in radio astronomy,  $T_B = \frac{c^2}{2\nu^2 k} I_\nu$   
A convenient unit [K] rather than [ $\text{erg s}^{-1} \text{cm}^{-2} \text{sr}^{-1} \text{Hz}^{-1}$ ]

**Antenna Temperature**  $T_A = \frac{c^2}{2\nu^2 k} I_\nu$  is linear with intensity.

In radio frequencies,  $T_A \approx T_B$ .

Other temperatures related to the Planck spectrum ...

**Color Temperature**  $\leftrightarrow$  shape (slope between two freq.)

## Effective Temperature

The total flux of a source equals to that of a blackbody of the temperature

$$F = \int I_\nu \cos \theta \, d\nu \, d\omega \equiv \sigma T_{\text{eff}}^4 \quad \sigma = \frac{2\pi^5 k^4}{15c^2 h^3}$$

For a star (spherically symmetric), luminosity

$$L = 4\pi R_*^2 \sigma T_{\text{eff}}^4$$

## Exercise

1. What is the age of Vega? How is this known?
2. What is the mass of the Sun? How is this known?
3. What is the age/mass/metallicity of Alpha Sco?

# Gas Dynamics

**Probability Distribution** = the distribution of speeds for a gas at a certain temperature (Maxwell-Boltzmann distribution)

$$\frac{dN}{N} = f(v) d^3 v = \left(\frac{m}{2\pi kT}\right)^{3/2} e^{-\frac{mv^2}{2kT}} d^3 v$$

$$d^3 v = dv_x dv_y dv_z = 4\pi v^2 dv$$

In 1-d scalar form,  $f(v) dv = 4\pi v^2 \left(\frac{m}{2\pi kT}\right)^{3/2} e^{-\frac{mv^2}{2kT}} dv$

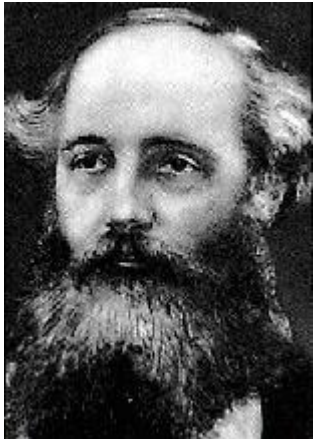

Skewed to the right (higher velocities)

cf Gaussian distribution; normal distribution; error function

$$f(x) = \frac{1}{\sigma\sqrt{2\pi}} e^{-\frac{1}{2}\left(\frac{x-\mu}{\sigma}\right)^2}$$



$$\int f(v) dv = 1$$

Doppler shift → a distribution of the line of sight velocities

$$a = \sqrt{\frac{kT}{m}}$$

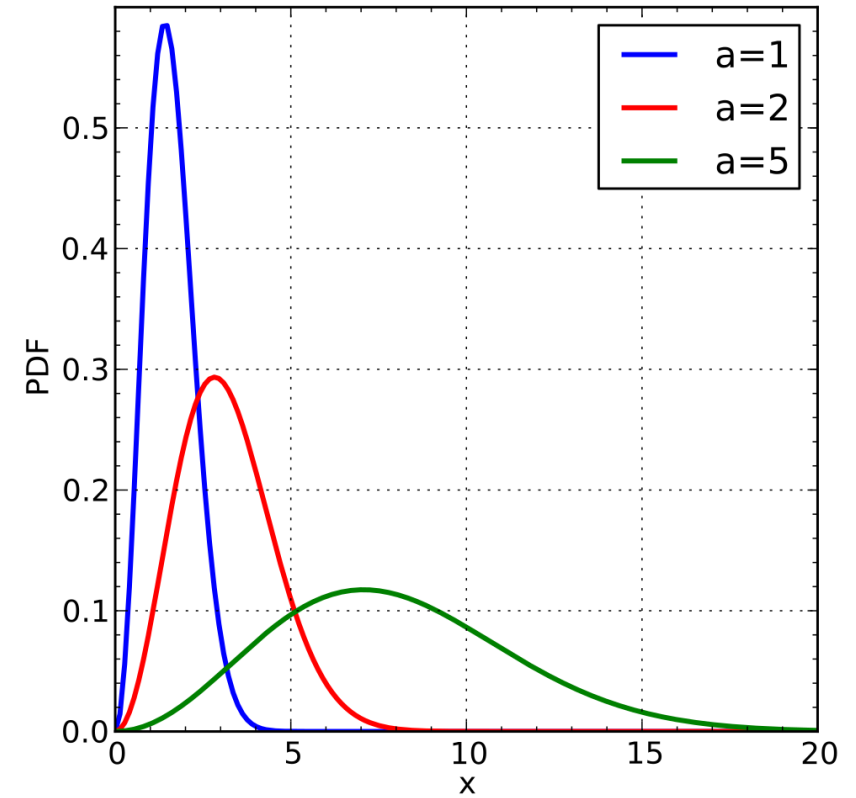

In momentum space, the probability of  $p$  in  $dp$

$$f(p) dp = \left( \frac{1}{2\pi m kT} \right)^{3/2} \exp\left( -\frac{p^2}{2m kT} \right) 4\pi p^2 dp$$

$$\frac{dN(v)}{N_{\text{total}}} = \left(\frac{2}{\pi}\right)^{3/2} \left(\frac{m}{2\pi kT}\right)^{3/2} e^{-\frac{mv_r^2}{2kT}} dv_r$$

This is the fraction of particles in the speed interval  $(v, v + dv)$  in the line of sight (radial) component, therefore the Doppler effect is exercised.

- ✓  $v_p$  **most probable speed** = max of  $f(v)$ : highest probability

$$v_p = \sqrt{\frac{2kT}{m}}$$

- ✓  $\langle v \rangle$  **mean speed** = expected value,  $\langle v \rangle = \int_0^\infty v f(v) dv$

$$\langle v \rangle = \sqrt{\frac{8kT}{\pi m}} = \frac{2}{\sqrt{\pi}} v_p = 1.128 v_p$$

- ✓  $v_{\text{rms}}$  **root-mean square speed** =  $\left( \int_0^\infty v^2 f(v) dv \right)^{1/2}$

$$v_{\text{rms}} = \sqrt{\frac{3kT}{m}} = \sqrt{\frac{3}{2}} v_p = 1.225 v_p$$

$$v_{\text{rms}} > \langle v \rangle > v_p$$

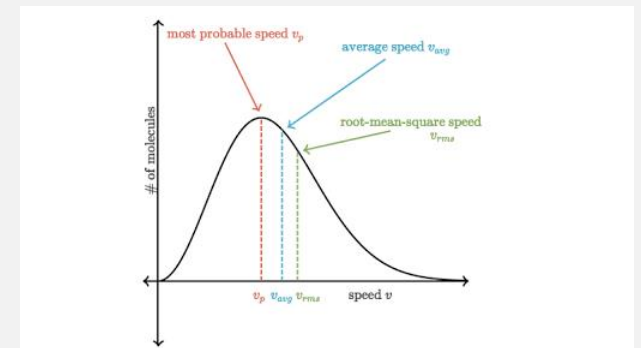

# For a Maxwell-Boltzmann (thermal) distribution

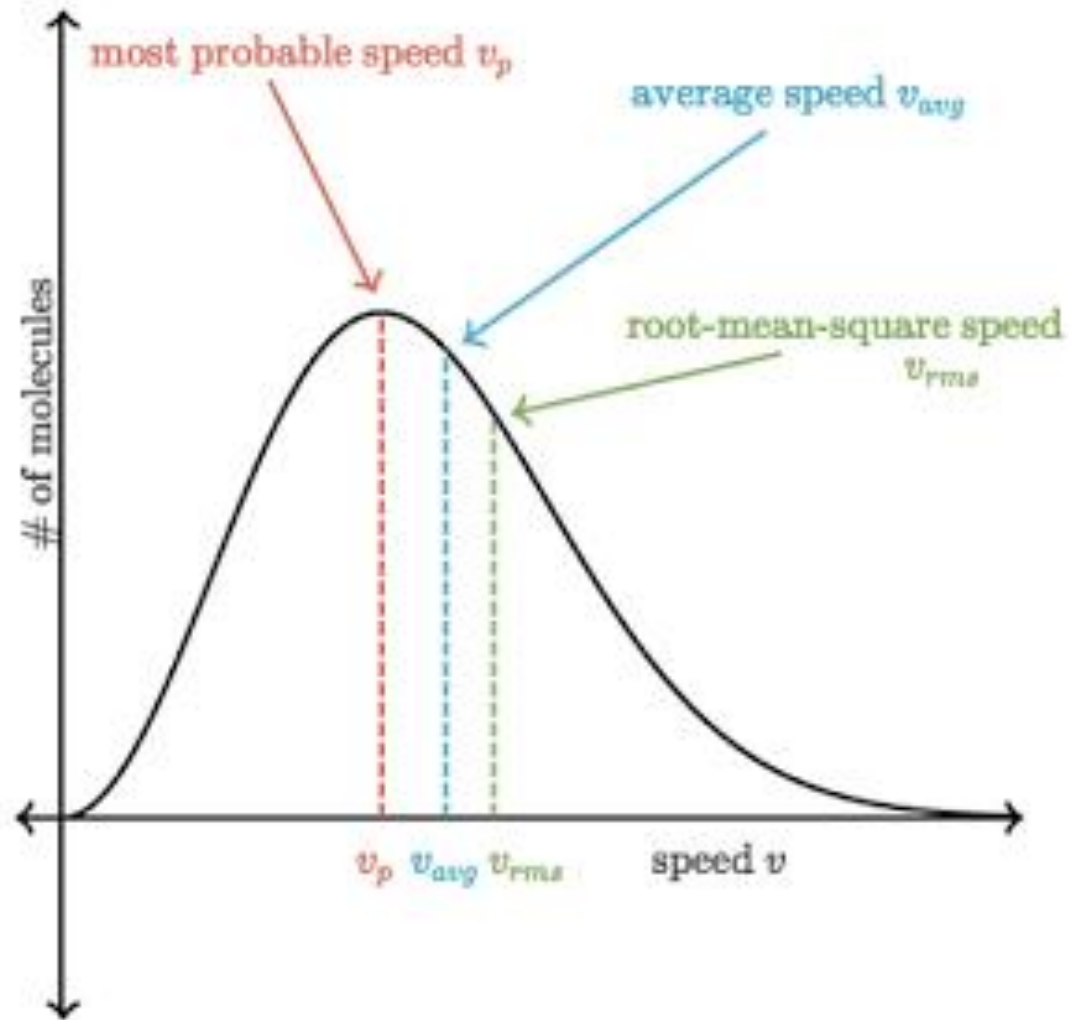

The 3-sigma rule: 68-95-99.7;  
e.g., a 3- $\sigma$  outlier is 3 chances out of 1000 in a normal distribution.

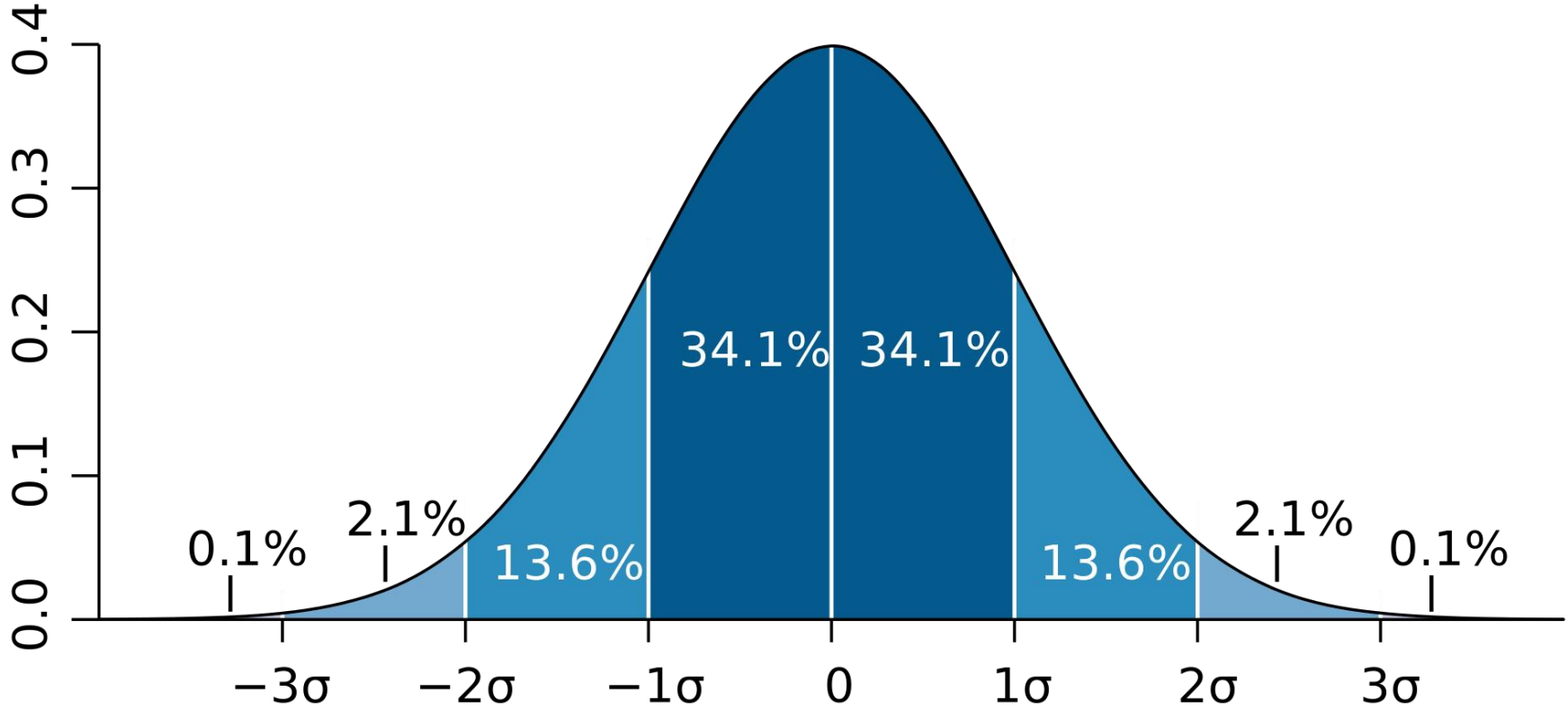

68.27, 95.45, 99.73%

To parameterize a Gaussian distribution,  $x_0 \pm \sigma$  (s.d.)

$$f(x) = \frac{1}{\sigma\sqrt{2\pi}} \exp\left[-\frac{(x-x_0)^2}{2\sigma^2}\right]$$

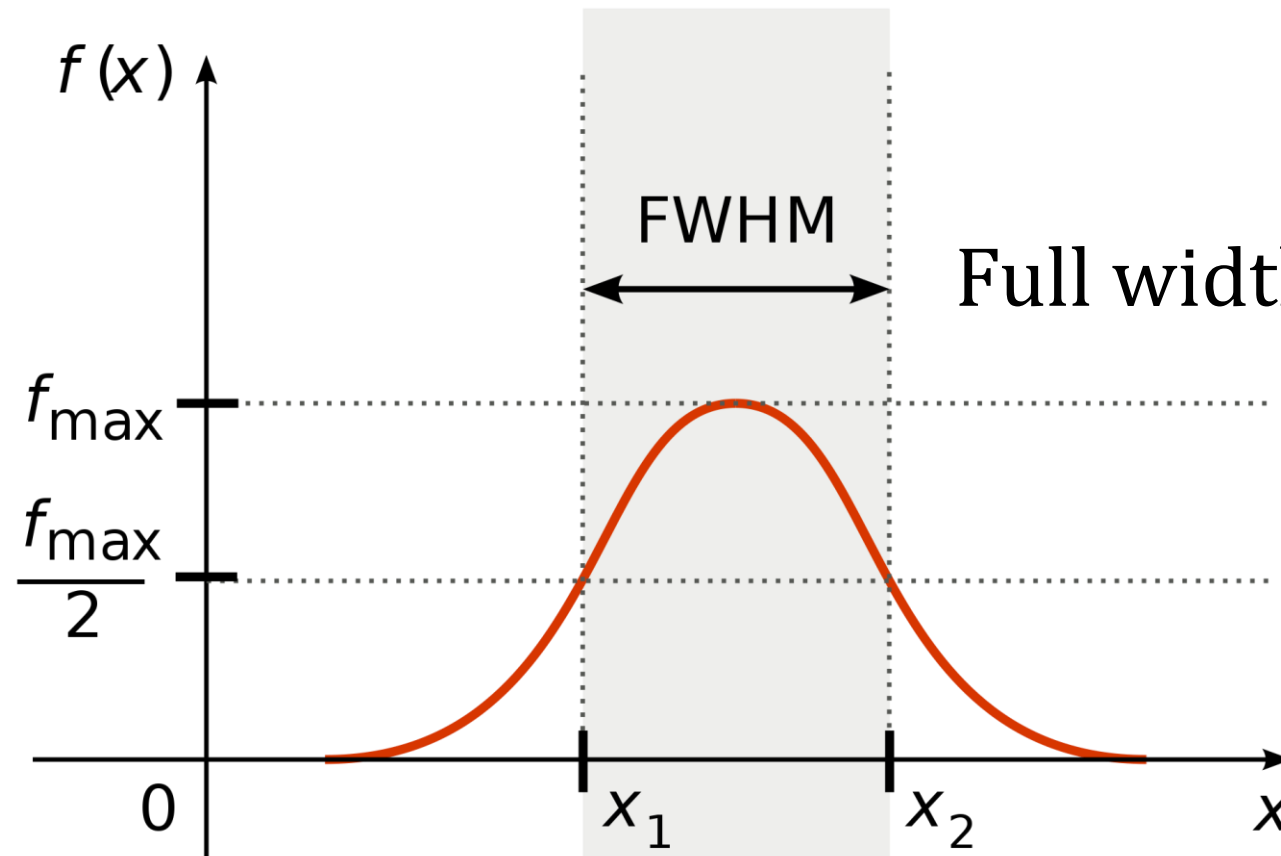

Full width at half maximum

$$\text{FWHM} = 2\sqrt{2 \ln 2} \sigma \approx 2.355 \sigma$$

# Ideal Gas Law The ideal gas **equation of state**

A combination of 3 laws

- ✓ Boyle's law  $V \propto 1/P$
- ✓ Charles's law  $V \propto T$
- ✓ Avogadro's law  $V \propto n_m$

$$PV = n_m RT = NkT$$

$$P = n kT = \frac{\rho}{\mu m_H} kT$$

$V$  (volume),  $P$  (pressure),  $T$  (temperature),  
 $\rho$ (mass density)

$n_m$ : number of moles

$R$ : ideal gas constant = 8.314 J/(K mol)

$k$ : Boltzmann constant =  $k_B = R/N_A$

$N_A$ : Avogadro constant =  $6.02 \times 10^{23} \text{ mol}^{-1}$

$N$ : number of total particles

$n$ : volume number density

This equation is valid if interaction is negligible, i.e., if density is low  $\rightarrow$  OK in normal stars in the low-density upper layers or even in the deep hot regions.

## Exercise

1. What is the temperature at the center? (How is this known?)
2. What is the pressure at the core of the Sun? What kind of gas particles dominate there? How fast do they move?
3. How old is the Sun? The Earth? Moon?



# Mean molecular weight (per particle)

$$\mu = \bar{m}/m_H \text{ (average mass per particle, in unit of amu)}$$

In a fully ionized gas (e.g., in stellar interior),

$$\begin{aligned} \mu &= 1/2 \text{ (H) ... 2 particles per } m_H \rightarrow 2X = \text{particles of H mass} \\ &= 4/3 \text{ (He) ... 3 particles per } 4 m_H \\ &\approx 2 \text{ (metals) ... } N \text{ particles per } 2 N \cdot m_H \end{aligned}$$

$$\frac{1}{\mu} \left[ \frac{\text{particles}}{\text{mass}} \right] = 2X + \frac{3}{4}Y + \frac{1}{2}Z \quad (X + Y + Z \equiv 1)$$

$$\rightarrow \mu = 4/(6X + Y + 2) \text{ for a fully ionized gas}$$

For the solar composition,

$$X_{\odot} = 0.747, Y_{\odot} = 0.236, Z_{\odot} = 0.017 \rightarrow \mu_{\odot} \approx 0.6$$

Recent revision  $Z_{\odot} = 0.0152$  (Caffau+11)

## Mean molecular weight per electron

Sometimes  $\mu_e$  is used = **equivalent mass ( $m_H$ ) per electron**, relevant when electrons provide the main gas pressure in the degenerate state.

$$\rho = m_H \mu_e n_e$$

For complete ionization,  $\mu_e = \frac{2}{1+X}$

Note that  $P$  and  $T$  must be continuous as a function of depth inside a star, but  $\mu$  and therefore  $\rho$  can be discontinuous.

## Exercise

What is the mean molecular weight of

- (1) an H I cloud;
- (2) an all-He gas (completely ionized versus neutral);
- (3) a molecular cloud;
- (4) a Pop II star

For an ideal gas,  $P = \frac{N}{V}kT = \frac{\rho}{\mu m_H}kT$

$$\frac{dP}{P} = \frac{d\rho}{\rho} + \frac{dT}{T} \quad \text{and} \quad PdV + VdP = NkdT$$

First law of thermodynamics (conservation of energy)

$$dQ = dU + PdV$$

For constant  $V$ ,  $c_V = \left(\frac{dQ}{dT}\right)_V = \frac{dU}{dT}$

$$dQ = dU + NkdT - VdP = \left(\frac{dU}{dT} + Nk\right) dT - VdP$$

So for constant  $P$ ,  $c_P = \left(\frac{dQ}{dT}\right)_P = \frac{dU}{dT} + Nk = c_V + Nk$

Hence  $c_P = c_V + Nk$ ,

and  $\gamma = c_P/c_V = (Nk + c_V)/c_V$

$$\gamma = \frac{Nk}{c_V} + 1$$

An isothermal (= constant in temperature) process:  
internal energy does not change

An adiabatic process:  $dQ = 0$

$$\begin{aligned}dQ &= c_V dT + PdV = c_V dT + (NkT/V)dV \\ &= dT/T + (c_P - c_V)/c_V (dV/V) = 0\end{aligned}$$

$$\log T + (\gamma - 1) \log V = \text{constant}$$

$$TV^{\gamma-1} = \text{constant}$$

$$PV^\gamma = \text{constant}$$

$$P^{1-\gamma}T^\gamma = \text{constant}$$

$\gamma$ : heat capacity ratio  
= adiabatic index  
= Laplace's coefficient  
= isentropic (adiabatic and reversible) expansion factor

# Average Kinetic Energy

$$f(p) dp = \left( \frac{1}{2\pi mkT} \right)^{3/2} \exp\left( -\frac{p^2}{2mkT} \right) 4\pi p^2 dp$$

$$E_{\text{av}} = \int_0^\infty \frac{p^2}{2m} f(p) dp = \frac{3}{2} kT$$

for the translational (3-d) kinetic energy of an ideal monatomic gas.

$$\text{For a diatomic gas } E_{\text{av}} = \int_0^\infty \frac{p^2}{2m} f(p) dp = \frac{5}{2} kT$$

(with 2 additional rotational degrees of freedom.)

$$\text{The gas sound speed, } C_s = \sqrt{\frac{\gamma}{3}} v_{\text{rms}} = \sqrt{\frac{f+2}{3f}} v_{\text{rms}}$$

$$\text{In general, } C_s^2 = \left( \frac{\partial P}{\partial \rho} \right)_s = \frac{\gamma P}{\rho} = \gamma \frac{kT}{m}$$

# Gas Thermodynamics

**Heat capacity:** heat supplied to increase one degree in temperature;  
 $C_P$  and  $C_V$  [joule  $K^{-1}$ ] =  $\Delta Q / \Delta T$

**Specific heat capacity** (=per unit mass),  $c_P$  (at constant pressure)  
or  $c_V$  (at constant volume)

$$C_P - C_V = k_B$$

$$C_P / C_V = \gamma > 1$$

$\gamma$ : the **adiabatic index** or **heat capacity ratio**

e.g., dry air,  $\gamma = 1.403$  ( $0^\circ\text{C}$ ), = 1.400 ( $20^\circ\text{C}$ )

$\text{O}_2$ ,  $\gamma = 1.400$  ( $20^\circ\text{C}$ ), = 1.397 ( $200^\circ\text{C}$ )

$\text{H}_2\text{O}$ ,  $\gamma = 1.330$  ( $20^\circ\text{C}$ ), = 1.310 ( $200^\circ\text{C}$ )

A gravitating star has a negative heat capacity.

Wet air  $\gamma$  smaller

Cool, dry air stable against convection  $\rightarrow$  good weather

## To Determine $\gamma$ of a Star

For an ideal gas,  $u_i = \frac{1}{2}kT$  per degree of freedom

Equipartition of energy  $\rightarrow u = \Sigma u_i = \frac{n}{2}kT$  for  $n$  dof

$$\text{Since } c_V = \left(\frac{\partial u}{\partial T}\right)_V = \frac{n}{2}k, \text{ and } \frac{c_P}{c_V} \equiv \gamma = \frac{nk/2+k}{nk/2} = 1 + \frac{2}{n}$$

For an ideal gas,  $n = 3, \gamma = 5/3$

For a photon gas,  $n = 6, \gamma = 4/3$

(3 propagation directions, each with 2 polarizations)

For a monatomic gas, dof=3  $\rightarrow \gamma = 5/3 = 1.67$

For a diatomic gas, dof =5  $\rightarrow \gamma = 7/5 = 1.4$



## Note

When a gas cell rises in the atmosphere, it expands and cools almost adiabatically, i.e., with little heat exchange (air is a poor heat conductor), but keeps the same pressure and temperature, balanced with the surroundings.

<http://farside.ph.utexas.edu/teaching/sm1/lectures/node56.html>

# Boltzmann (Gibbs) Distribution

The probability distribution of a system of temperature  $T$  at a certain state, e.g., in energy level 2 relative to level 1,

$$p \propto e^{-E_{21}/kT}$$

$e^{-E_{21}/kT}$ : Boltzmann factor

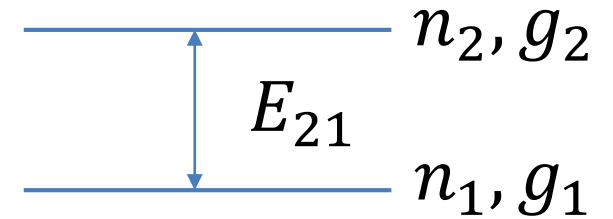

This differs from the Maxwell-Boltzmann distribution that specifies the probabilities of particle velocities/energies in an ideal gas.

# Boltzmann Excitation Equation

$e^{-E_{21}/kT}$ : Boltzmann factor

Population ratio between two excited states (of the same  $r$ -times ionized species)

$$\frac{n_2}{n_1} = \frac{g_2}{g_1} e^{-E_{21}/kT}$$

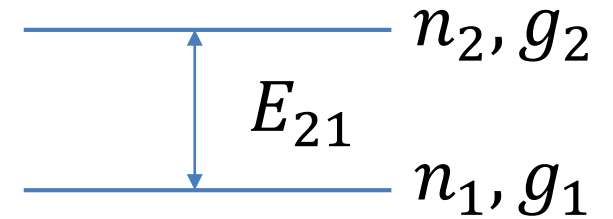

$n_i$ : number density of the particles in the  $i$ -th energy state

$g_i$ : **statistical weight** of the  $i$ -th energy state

= degeneracy of the level

= number of states with different quantum numbers but with the same energy

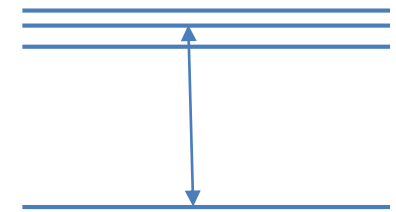

$E_{21}$ : difference in excitation energies (wrt to ground state) =  $h\nu$

It really should have been  $n_i^r$  or  $g_i^r$  for the same  $r$ -times ionization.

When Zeeman splitting (by magnetic field) is neglected, all projections of the angular momentum are degenerate in energy, so  $g_i^r = 2 J_i^r + 1$  for  $r$ -times ionization.

$J_i^r$ : angular momentum of the state

For the hydrogen atom (a pure  $1/r$  potential)

$$E_n = -\frac{13.6}{n^2} \text{ [eV]}, g = 2n^2,$$

where  $n = 1, 2, 3, \dots$  is the principal quantum number.

For rotating linear molecules (e.g., CO) have  $g = 2J + 1$ , where  $J = 0, 1, 2, \dots$  is the angular momentum quantum number.

For each  $J$ , there are  $2J + 1$  possible z-components,

$$J_z = -J, -(J - 1), \dots, 0, 1, \dots, (J - 1), J$$

Table 11. The wavelengths in Å of the  $m \rightarrow n$  transitions of hydrogen for  $n=1$  to 6,  $m=2$  to 21, and  $m=\infty$ , and for the  $n=4$  Pickering series for ionized helium ( $\text{He II}$ )<sup>1</sup>. Here the wavelengths are in Å where  $1 \text{ Å} = 10^{-8} \text{ cm}$

Series	Lyman ( $n=1$ )	Balmer ( $n=2$ )	Paschen ( $n=3$ )	Brackett ( $n=4$ )	Pfund ( $n=5$ )	Humphreys ( $n=6$ )	Pickering ( $\text{He}^+, n=4$ )
2	1,215.67						
3	1,025.72	6,562.80					
4	972.537	4,861.32	18,751.0				
5	949.743	4,340.46	12,818.1	40,512.0			10,123.64
6	937.803	4,101.73	10,938.1	26,252.0	74,578		6,560.10
7	930.748	3,970.07	10,049.4	21,655.0	46,525	123,680	5,411.52
8	926.226	3,889.05	9,545.98	19,445.6	37,395	75,005	4,859.32
9	923.150	3,835.38	9,229.02	18,174.1	32,961	59,066	4,541.59
10	920.963	3,797.90	9,014.91	17,362.1	30,384	51,273	4,338.67
11	919.352	3,770.63	8,862.79	16,806.5	28,722	46,712	4,199.83
12	918.129	3,750.15	8,750.47	16,407.2	27,575	43,753	4,100.04
13	917.181	3,734.37	8,665.02	16,109.3	26,744	41,697	4,025.60
14	916.429	3,721.94	8,598.39	15,880.5	26,119	40,198	3,968.43
15	915.824	3,711.97	8,545.39	15,700.7	25,636	39,065	3,923.48
16	915.329	3,703.85	8,502.49	15,556.5	25,254	38,184	3,887.44
17	914.919	3,697.15	8,467.26	15,438.9	24,946	37,484	3,858.07
18	914.576	3,691.55	8,437.96	15,341.8	24,693	36,916	3,833.80
19	914.286	3,686.83	8,413.32	15,260.6	24,483	36,449	3,813.50
20	914.039	3,682.81	8,392.40	15,191.8	24,307	36,060	3,796.33
21	913.826	3,679.35					3,781.68
$\infty$	911.5	3,646.0	8,203.6	14,584	22,788	32,814	3,644.67

<sup>1</sup> Data from WIESE, SMITH, and GLENNON (1966).

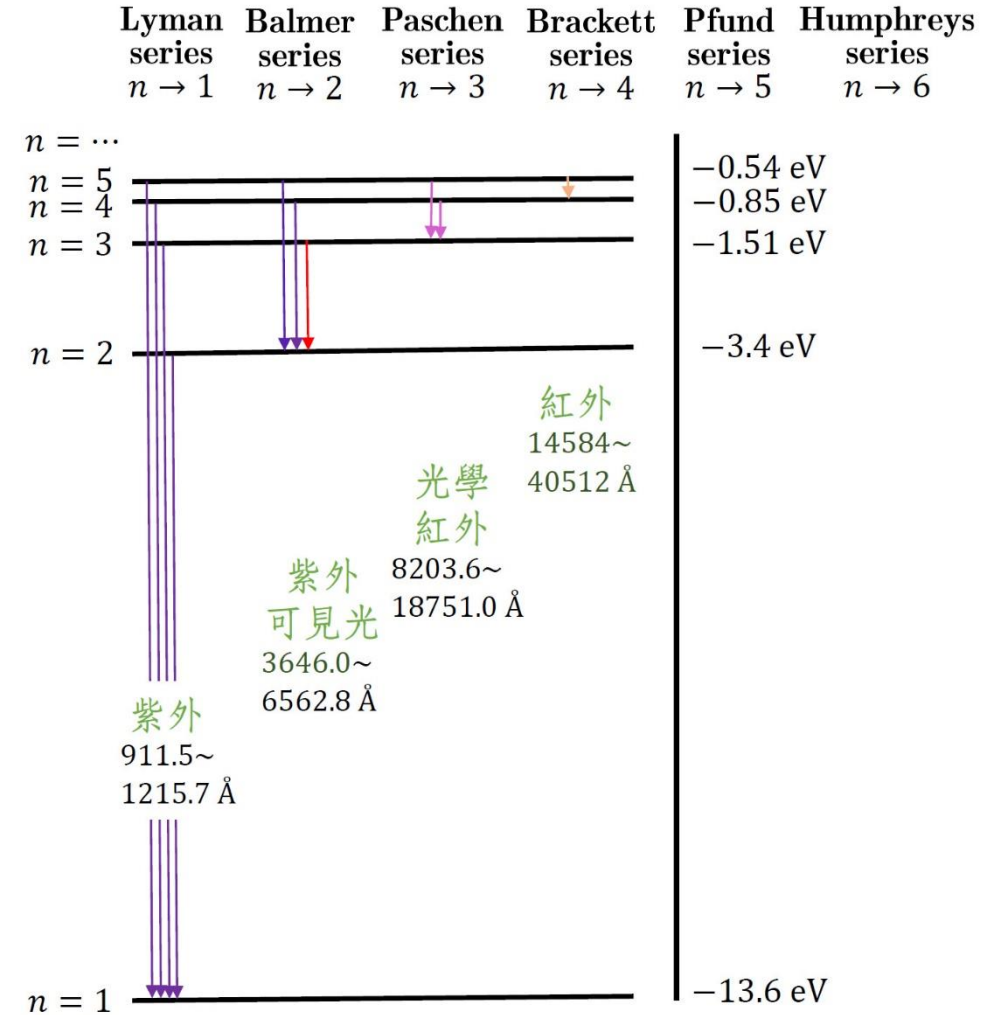

Lang

For the H atom, the ground “state” has two quantum states of the same energy  $-13.6$  eV,  $g_1 = 2$ .

For the first excited states  $g_2 = 8$ .

### Exercise

Calculate the wavelength of the  $H\alpha$  line (transition between  $n = 3$  and  $n = 2$  levels).

Adopting a solar photospheric temperature of  $T = 5800$  K, what is the ratio of the population of the first excited state to the ground state of H? To all states?

# Saha Ionization Equation

Population ratio between two ionization stages

$$\frac{n_{r+1} n_e}{n_r} = \frac{G_{r+1} g_e}{G_r} \frac{(2\pi m_e kT)^{3/2}}{h^3} e^{-\chi_r/kT}$$

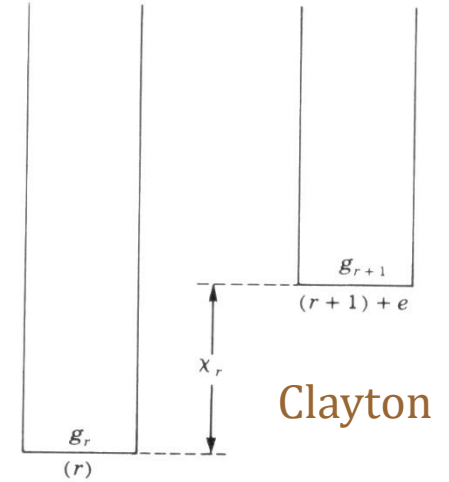

$n_r$ : number density of the particles in the  $r$ -th ionized state

$n_e$ : number density of free electrons

$G_r, g_e$ : **partition functions** of the ionized species, and of the electron = sum of the statistical weights of all bound states, each weighted by the Boltzmann factor

$G_r = \sum_i g_{r,i} e^{-\frac{E_i}{kT}}$ , very often  $G_1$  dominates;  $g_e = 2$

$\chi_r$ : ionization potential from the ionization stage  $r$  to  $r + 1$

Numerically,

$T$  [K] and  $\chi_r$  [eV]

$$\log \frac{n_{r+1} n_e}{n_r} = \log \frac{G_{r+1} g_e}{G_r} + 15.6826 + \frac{3}{2} \log T - \frac{5039.95 \chi_r}{T}$$

For hydrogen, neutral  $G_1 \approx g_1 = 2$  (i.e., most of the neutral H is in the ground state), and ionized  $G_2 = 1$  (just the proton).

For neutral ground state of H,  $\chi_r = 13.6$  eV

Sometimes the electron pressure  $P_e$  is used instead of the number density  $n_e$ , via  $P_e = n_e kT$ , for which  $P_e \approx 1$  dyne  $\text{cm}^{-2}$  for cool stars, and  $P_e \approx 1000$  dyne  $\text{cm}^{-2}$  (=100 Pa) for hotter stars.



Numerically,

$$\log \left[ \frac{n_{r+1}}{n_r} P_e [\text{Pa}] \right] = -1.48 + \log \frac{G_{r+1}}{G_r} + \frac{5}{2} \log T [\text{K}] - \frac{5040 \chi_r [\text{eV}]}{T [\text{K}]}$$

where  $\langle P_e \rangle \approx 100 [\text{Pa}]$

$$1 \text{ bar} = 10^5 \text{ Pa} = 0.987 \text{ atm} = 750 \text{ Torr}$$

$$1 \text{ Pa} = 1 \text{ N/m}^2 = 10 \text{ dyne/cm}^2$$

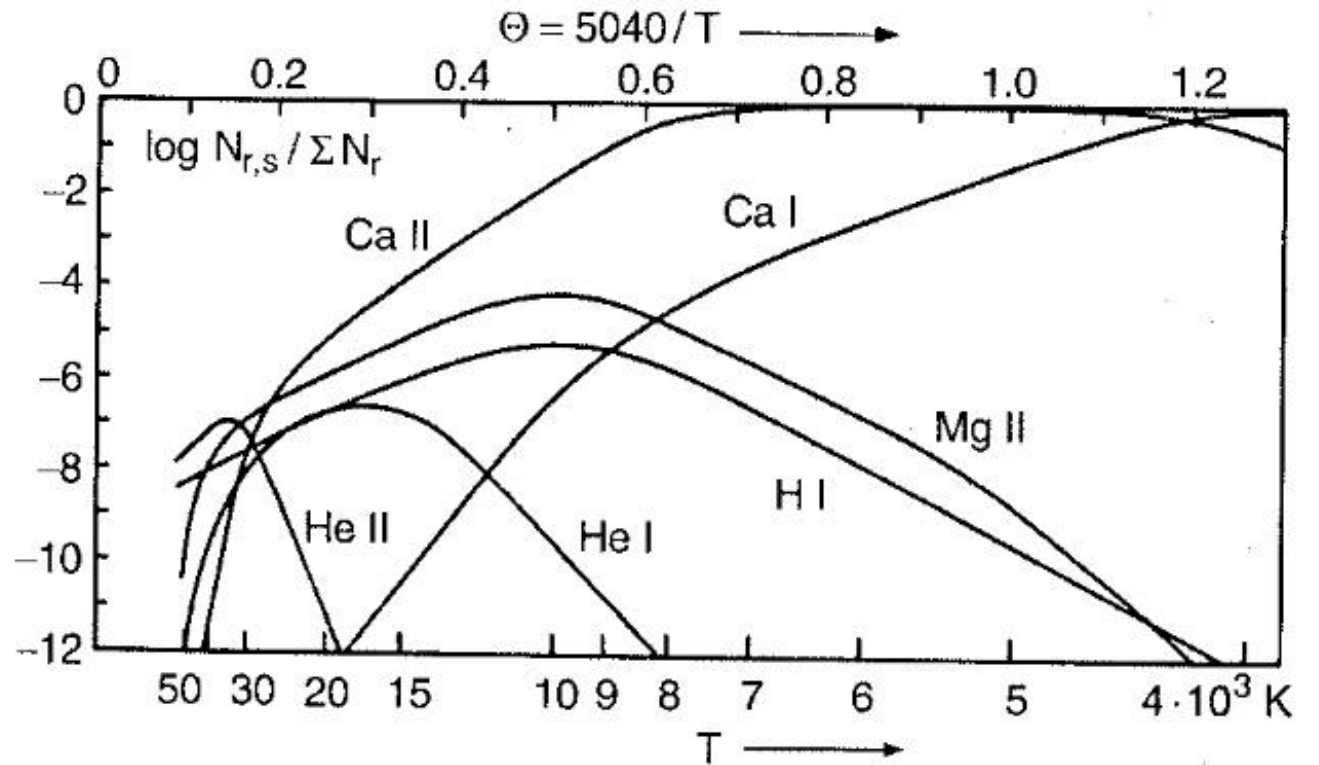

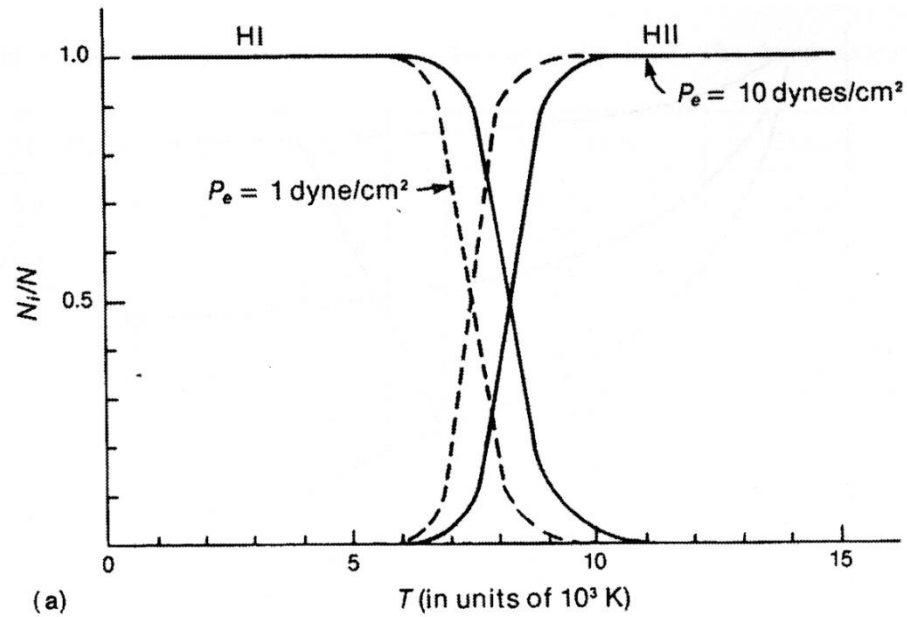

(a)

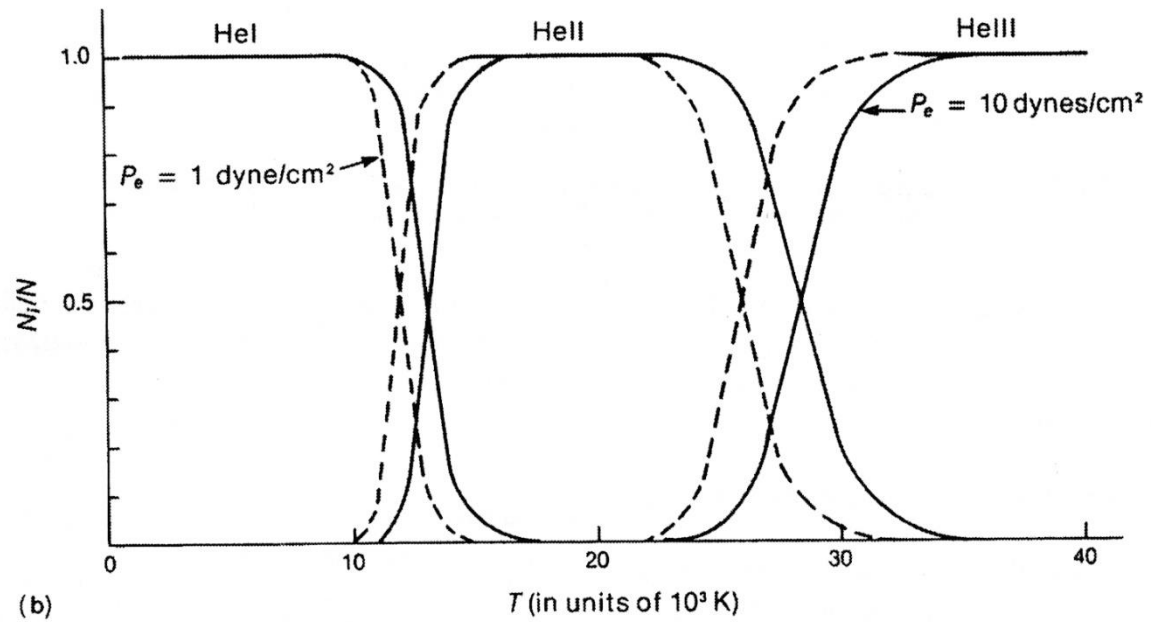

(b)

“Metals” supply plenty electrons. Given a temperature, e.g., calcium ( $\chi = 6.11$  eV) loses electrons at a rate greater than hydrogen does ( $\chi = 13.6$  eV).

The recapture (recombination) rate of ions depends on the electron density.

$\chi$	I	II	III	IV
H	13.60			
He	24.58	54.40		
C	11.26	24.38	47.87	64.48
N	14.53	29.59	47.43	77.75
O	13.61	35.11	54.89	77.39

Ionization energies

## Exercise

Compute the ionization fraction,  $x \equiv n_{II}/n$ , where  $n = n_I + n_{II}$  is the total H number density,  $n_I = n_{HI}$ ,  $n_{II} = n_{HII}$ , and charge neutrality gives the electron density  $n_e = n_{II}$ .

Saha equation becomes



# Radiative Transfer

Heated gas of density  $\rho$   
and volume  $dV = dA ds$

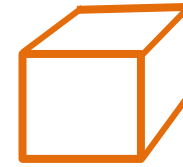

Interaction of matter with radiation  
→ absorption, emission, scattering

Radiation in all directions,  $dE_\nu = j'_\nu \rho dV d\nu$

$j'_\nu$ : the **mass emission coefficient** of the material

$j_\nu \equiv j'_\nu \rho$  [erg cm<sup>-3</sup> s<sup>-1</sup> Hz<sup>-1</sup> sr<sup>-1</sup>] is the monochromatic  
emission coefficient →  $j = \int j_\nu d\nu$  **emission coefficient**

$j_\nu$  is directional →  $dI_\nu = j_\nu ds$

For isotropic emission, the **emissivity** is

$$\epsilon_\nu \text{ [erg g}^{-1} \text{ s}^{-1} \text{ Hz}^{-1}] = 4\pi j_\nu / \rho$$

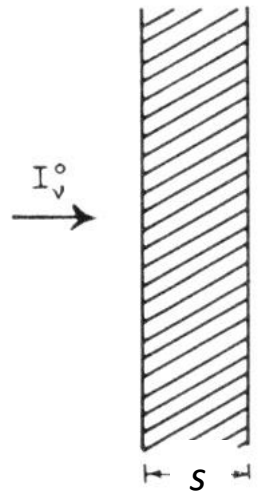

Consider radiation through a slab of thickness  $dx$ , the intensity is reduced by an amount

$$dI_\nu = -\kappa'_\nu \rho I_\nu ds$$

Define  $\kappa_\nu = \kappa'_\nu \rho$  [ $\text{cm}^{-1}$ ], where  $\rho$  is material density,

$\kappa'_\nu$  [ $\text{cm}^2 \text{ gm}^{-1}$ ] : **mass absorption coefficient (opacity coefficient)**

$\kappa_\nu$  [ $\text{cm}^{-1}$ ] : **absorption coefficient**

Opacity  $\rightarrow$  spectral lines

$$dI_\nu = -\kappa_\nu I_\nu ds \dots\dots\dots (1)$$

Dividing (1) by  $I_\nu$  and integrating

$$\rightarrow \ln I_\nu = -\kappa_\nu s + \text{const}$$

$$I_\nu = I_\nu^0 e^{-\kappa_\nu s}$$

$I_\nu^0$  is the incident beam

Introducing (dimensionless) **optical depth**  $\tau_\nu$ ,

$$d\tau_\nu = \kappa_\nu ds$$

we get

$$I_\nu = I_\nu^0 e^{-\tau_\nu}$$

$\tau_\nu$  determines the fraction of the intensity from that layer that reaches the surface; e.g., from a layer of  $\tau_\nu = 2$ , a fraction of  $e^{-2} \approx 0.14$  reaches the surface.

The apparent “surface” of a star (photosphere)  $\rightarrow \tau_\nu \approx 1$ ,  $1/e = 37\%$  radiation emerges from there.

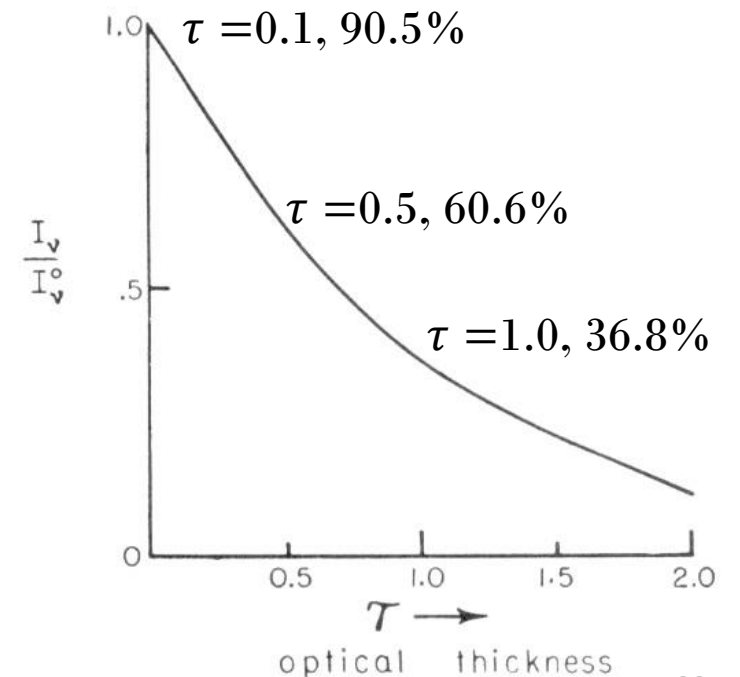
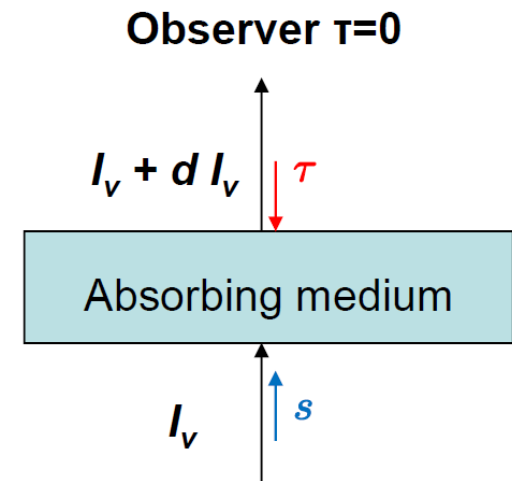



Optical thickness:

- ✓  $\tau_\nu \gg 1 \rightarrow$  optically thick = opaque
  - ✓  $\tau_\nu \ll 1 \rightarrow$  optically thin = transparent
- $\tau_\nu \approx 1 \rightarrow$  “surface”

$j_\nu dt dV d\omega d\nu =$  Energy emitted

$\kappa_\nu I_\nu dt dV d\omega d\nu =$  Energy absorbed  
(need something to absorb from)

When  $\kappa_\nu^{\text{abs}}$  and  $\kappa_\nu^{\text{sca}}$  are independent of  $\nu$ , the opacities are gray.

*Why is the sky blue? Why is a cloudy sky gray?*

## Exercise

A star is measured  $m_V = +2$  above the Earth atmosphere, and measured  $m_V = +3$  on the ground. What is the optical depth of the atmosphere along the line of sight to the star?

Answer: the brightness is attenuated by 2.512 times, so

$$\frac{1}{2.512} = e^{-\tau}$$

and  $\tau = 0.92$

# Radiative Transfer Equation

... governs how specific intensity varies with emission and absorption by a medium

$$\frac{dI_\nu}{ds} = -\kappa_\nu I_\nu + j_\nu$$

If there is scattering  $\rightarrow$  radiation in and out of the solid angle  
 $\rightarrow$  an integrodifferential equation  $\rightarrow$  solution is complicated

$$\frac{dI_\nu}{d\tau_\nu} = -I_\nu + \frac{j_\nu}{\kappa_\nu} \equiv -I_\nu + S_\nu$$

$$\tau_\nu(s) = \int_{s_0}^s \kappa_\nu(s') ds'$$

$S_\nu \equiv \frac{j_\nu}{\kappa_\nu}$  is the **source function**.

This equation is used more often, because  $S_\nu$  is a simpler function of physical quantities, and  $\tau_\nu$  is more intuitive (dimensionless). <sup>69</sup>

(1)  $\kappa_\nu = 0$  (emission only)

$$I_\nu(s) = I_\nu(s_0) + \int_{s_0}^s j_\nu(s') ds'$$

*Increase in brightness equals to the emission coefficient integrated along the line of sight.*

(2)  $j_\nu = 0$  (absorption only)

$$I_\nu(s) = I_\nu(s_0) \exp \left[ - \int_{s_0}^s \kappa_\nu(s') ds' \right]$$

*Brightness decreases exponentially by the absorption coefficient integrated along the line of sight.*

(3) In general

$$\frac{dI_\nu}{d\tau_\nu} = -I_\nu + S_\nu$$

$$I_\nu(\tau_\nu) = I_\nu(0) e^{-\tau_\nu} + \int_0^{\tau_\nu} \frac{j_\nu}{\kappa_\nu} e^{-\tau_\nu''} d\tau_\nu''$$

If  $j_\nu/\kappa_\nu = \text{const}$  (not valid in ISM but OK in stellar atmosphere)

$$I_\nu(\tau_\nu) = I_\nu(0) e^{-\tau_\nu} + \frac{j_\nu}{\kappa_\nu} (1 - e^{-\tau_\nu})$$

**Thermodynamic equilibrium** = no net flows of matter or of energy into a system

*Two systems in thermal equilibrium when  $T$  temperature the same*

*Two systems in mechanical equilibrium when  $P$  pressure the same*

*Two systems in diffusive equilibrium when  $\mu$  chemical potentials the same*

In **local thermodynamic equilibrium** (LTE)

$$(I_\nu)_{\text{LTE}} \rightarrow B_\nu(T) = \frac{2 h \nu^3}{c^2} \frac{1}{e^{h\nu/kT} - 1},$$

where  $n_\gamma(\nu) \equiv (c^2 / 2 h \nu^3) I_\nu$  (dimensionless) is called the **photon occupation number** = number of photons per mode of polarization

In LTE,  $dI_\nu/d\tau = 0 \rightarrow I_\nu = j_\nu/\kappa_\nu$   
 and  $I_\nu = B_\nu(T)$

$$\frac{dI_\nu}{d\tau_\nu} = -I_\nu + S_\nu$$

$j_\nu = B_\nu \kappa_\nu$  (Planck-Kirchhoff law)  
 cf Kirchhoff's circuit law

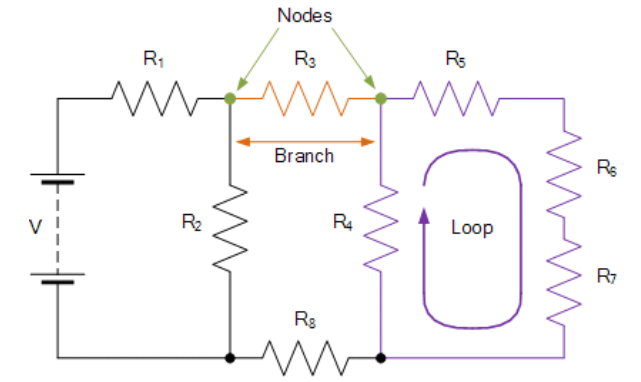

Kirchhoff:  $j_\nu/\kappa_\nu$  in TE depends only on  $T$  (Planck law not yet known then)  $\rightarrow$  good absorbers are also good emitters.  
 Valid only for thermal emission; e.g., not for scattering

Finally, the solution is  $I_\nu(\tau_\nu) = I_\nu(0) e^{-\tau_\nu} + B_\nu(T) (1 - e^{-\tau_\nu})$ ,  
 Under the assumptions of (1) LTE, and (2)  $T = \text{const}$

## Gustav Kirchhoff

**Gustav Robert Kirchhoff** (German: [ˈkɪʁçhɔf]; 12 March 1824 – 17 October 1887) was a German physicist who contributed to the fundamental understanding of electrical circuits, spectroscopy, and the emission of black-body radiation by heated objects.<sup>[a][2]</sup>

He coined the term black-body radiation in 1862. Several different sets of concepts are named "Kirchhoff's laws" after him, concerning such diverse subjects as black-body radiation and spectroscopy, electrical circuits, and thermochemistry. The Bunsen–Kirchhoff Award for spectroscopy is named after him and his colleague, Robert Bunsen.

### Contents

#### Life and work

- Kirchhoff's circuit laws
- Kirchhoff's three laws of spectroscopy
- Kirchhoff's law of thermal radiation
- Kirchhoff's law of thermochemistry

#### Works

#### See also

#### Notes

#### References

#### Further reading

#### External links

### Life and work

Gustav Kirchhoff was born on 12 March 1824 in Königsberg, Prussia, the son of Friedrich Kirchhoff, a lawyer, and Johanna Henriette Wittke.<sup>[3]</sup> His family were Lutherans in the Evangelical Church of Prussia. He graduated from the Albertus University of Königsberg in 1847 where he attended the mathematico-physical seminar directed by Carl Gustav

Gustav Kirchhoff

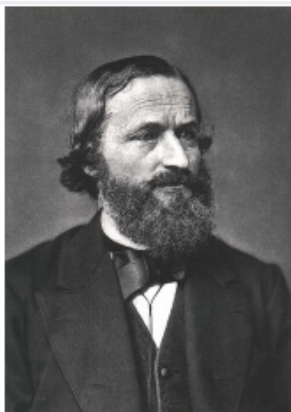

<b>Born</b>	<span>Gustav Robert Kirchhoff</span> <div>12 March 1824</div> <span><span><span><span></span></span> </span>Königsberg, Province of East Prussia, Kingdom of Prussia (now Kaliningrad, Russia)</span>
<b>Died</b>	<span>17 October 1887 (aged 63)</span> <div><span><span><span></span></span> </span>Berlin, Province of Brandenburg, Kingdom of Prussia,</div>

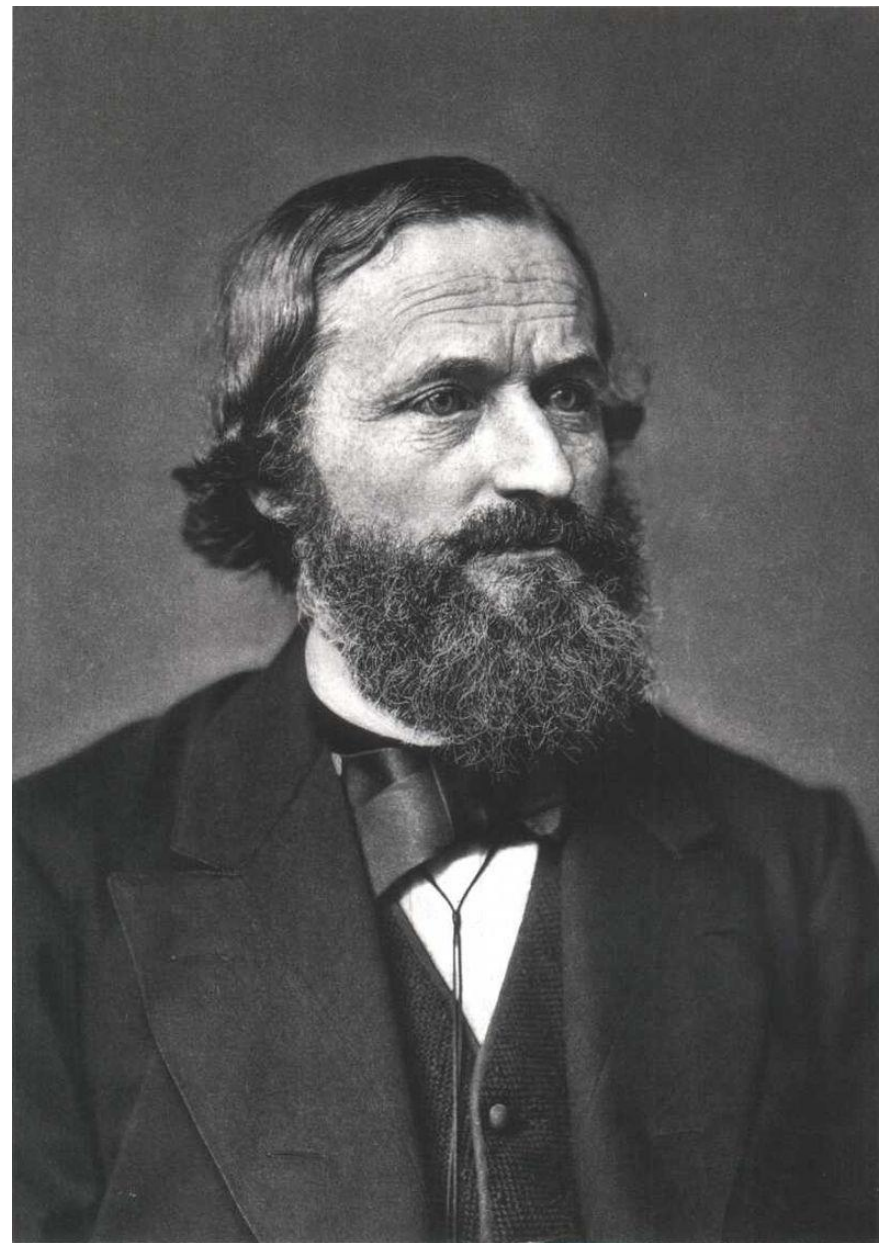



$$I_\nu(\tau_\nu) = I_\nu(0) e^{-\tau_\nu} + B_\nu(T) (1 - e^{-\tau_\nu})$$

In the Rayleigh-Jeans regime,  $B_\nu \propto T_e$ , and  $I \propto T$

$$T_B = T_B(0) e^{-\tau_\nu} + T_e (1 - e^{-\tau_\nu}) \quad h\nu \ll kT$$

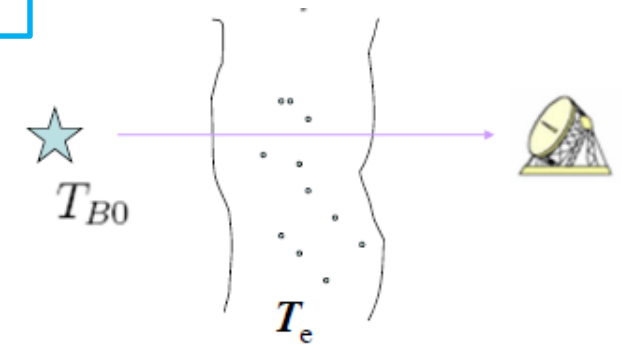

If background is zero, i.e.,  $T_B(0) = 0$ , and dropping  $\nu$ ,

(i)  $\tau \gg 1 \rightarrow T_B \rightarrow T_e$  (measuring only the “surface”)

(ii)  $\tau \ll 1 \rightarrow T_B \rightarrow \tau T_e$  (measuring the entire medium)

$$I_\nu(\tau_\nu) = I_\nu(0) e^{-\tau_\nu} + B_\nu(T) (1 - e^{-\tau_\nu})$$

What we actually measure is the flux density,

$$S_\nu = \int_{\text{source}} I_\nu d\omega \text{ [erg s}^{-1} \text{ cm}^{-2} \text{ Hz}^{-1}] \text{ cf. Jansky}$$

Integrating over the solid angle subtended by the source,

$$S_\nu = \int_{\text{source}}^{\Omega} B_\nu(T_e) (1 - e^{-\tau_\nu}) d\omega \approx \Omega B_\nu(T_e) (1 - e^{-\tau_\nu})$$

Point sources  $\rightarrow$  Jy

Extended sources  $\rightarrow$  Jy sr<sup>-1</sup>

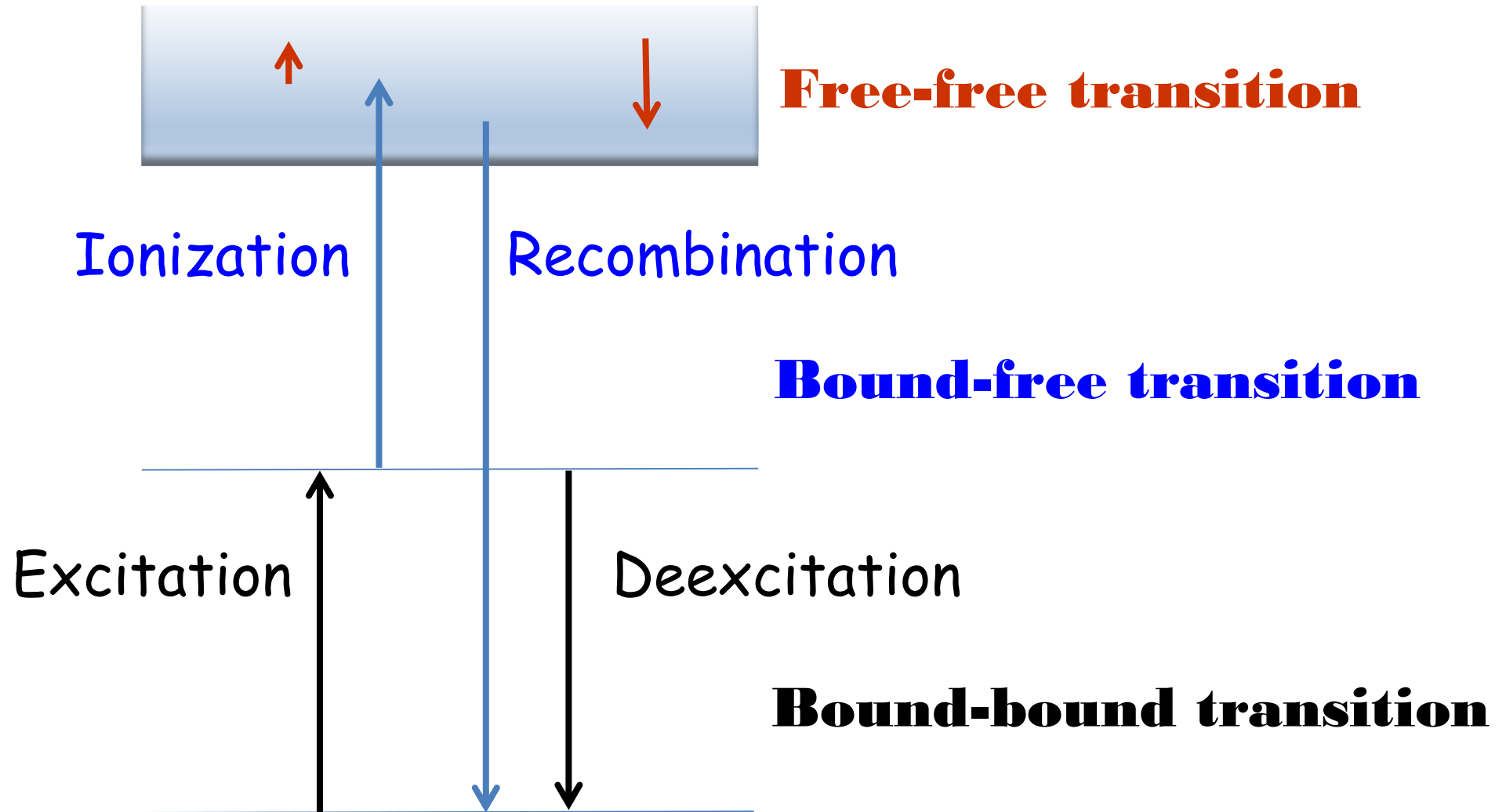

# Continuous Spectrum



# Emission Lines

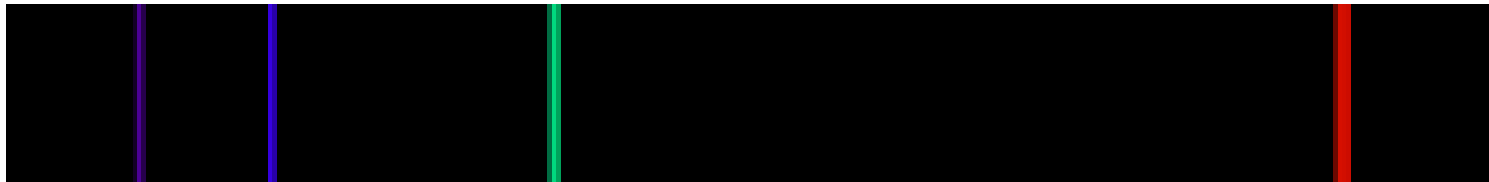

# Absorption Lines



Hot blackbody



Cloud of cooler gas

Prism

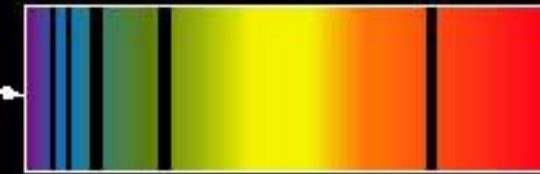

Prism

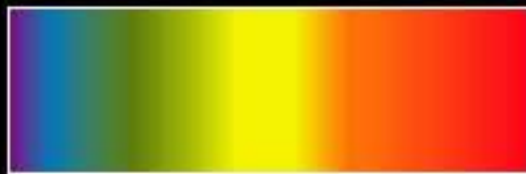

Prism



Geller et al  
"Universe"

# Emission vs Absorption

Two ways to decay down from an excited state

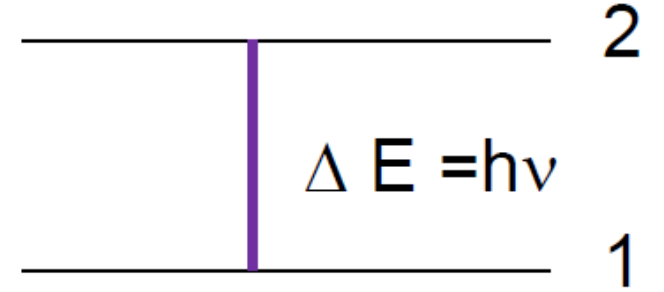

- **Spontaneous emission**

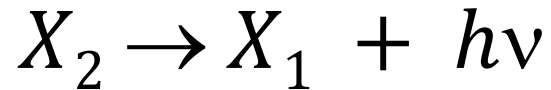

occurrence rate  $\leftrightarrow$  atomic properties

- **Stimulated emission**

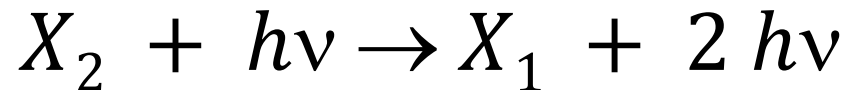

occurrence rate  $\leftrightarrow$  density of incoming photons of the same  $\nu$ , polarization, and direction of propagation

- **Collisional deexcitation  $\rightarrow$  no emission of photons**

# Einstein Coefficients

Einstein (1917)

Spontaneous emission

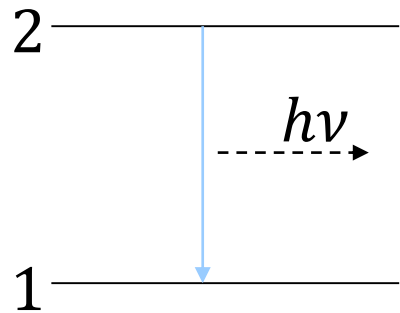

$$X_2 \rightarrow X_1 + h\nu$$

$$\nu = (E_2 - E_1)/h$$

$A_{21}$  --- probability [ $s^{-1}$ ]

$n_2 A_{21} dt$ : # of spontaneous radiative transitions during  $dt$

Stimulated (induced) emission      (Stimulated) absorption

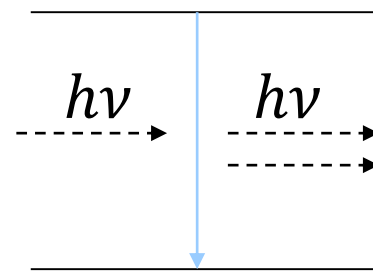

$$X_2 + h\nu \rightarrow X_1 + 2 h\nu$$

$B_{21}$

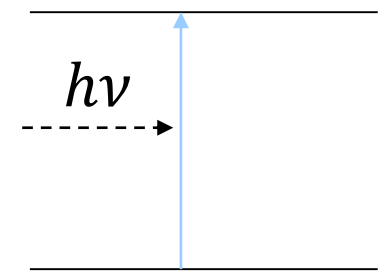

$$X_1 + h\nu \rightarrow X_2$$

$B_{12}$

$B I_\nu$  --- probability      or  $B u_\nu$  then unit different

$n_2 B_{21} I_\nu dt$  or  $n_1 B_{12} I_\nu dt$ : # of (stimulated) or radiative transitions during  $dt$  when irradiated with  $I_\nu$

Einstein

Separat-Abdruck aus:  
Mitteilungen der Physikalischen Gesellschaft Zürich - Nr. 18, 1916.

112 4

**Zur Quantentheorie der Strahlung**  
von A. Einstein.

Die formale Ähnlichkeit der Kurve der chromatischen Verteilung der Temperaturstrahlung mit dem Maxwell'schen Geschwindigkeits-Verteilungsgesetz ist zu frappant, als daß sie lange hätte verborgen bleiben können. In der Tat wurde bereits W. Wien in der wichtigen theoretischen Arbeit, in welcher er sein Verschiebungsgesetz

$$\rho = \nu^3 f\left(\frac{\nu}{T}\right) \quad (1)$$

ableitete, durch diese Ähnlichkeit auf eine weitergehende Bestimmung der Strahlungsformel geführt. Er fand hiebei bekanntlich die Formel

$$\rho = \alpha \nu^3 e^{-\frac{h\nu}{kT}} \quad (2)$$

welche als Grenzgesetz für große Werte von  $\frac{\nu}{T}$  auch heute als richtig anerkannt wird (Wien'sche Strahlungsformel). Heute wissen wir, daß keine Betrachtung, welche auf die klassische Mechanik und Elektrodynamik aufgebaut ist, eine brauchbare Strahlungsformel liefern kann, sondern daß die klassische Theorie notwendig auf die Reileigh'sche Formel

$$\rho = \frac{k\alpha}{h} \nu^2 T \quad (3)$$

führt. Als dann Planck in seiner grundlegenden Untersuchung seine Strahlungsformel

$$\rho = \alpha \nu^3 \frac{1}{e^{\frac{h\nu}{kT}} - 1} \quad (4)$$

auf die Voraussetzung von diskreten Energie-Elementen gegründet hatte, aus welcher sich in rascher Folge die Quantentheorie entwickelte, geriet jene Wien'sche Überlegung, welche zur Gleichung (2) geführt hatte, naturgemäß wieder in Vergessenheit.

Vor kurzem nun fand ich eine der ursprünglichen Wien'schen Betrachtung<sup>1)</sup> verwandte, auf die Grundvoraussetzung der Quanten-

<sup>1)</sup> Verh. d. deutschen physikal. Gesellschaft, Nr. 13/14, 1916, S. 318. In der vorliegenden Untersuchung sind die in der eben zitierten Abhandlung gegebenen Überlegungen wiederholt.

126/12

# “On the Quantum Theory of Radiation” from A. Einstein

<https://einstein.manhattanrarebooks.com/pages/books/17/albert-einstein/zur-quantentheorie-der-strahlung-on-the-quantum-theory-of-radiation>



# Transition Probability

Considering a 2-level system, we calculate the emission arising from the transition:

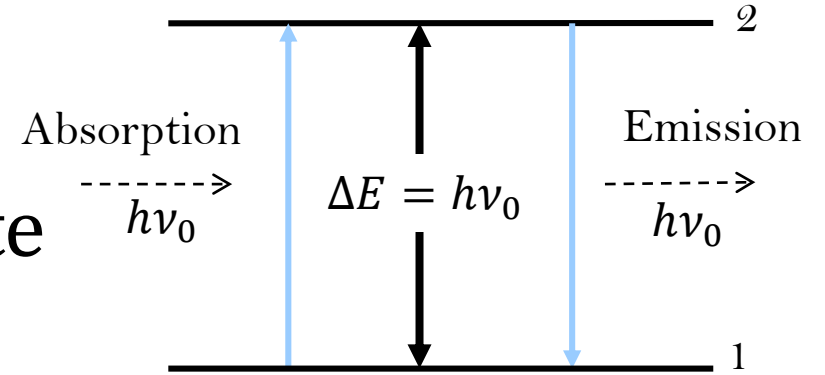

$$j_\nu \text{ [erg s}^{-1} \text{ cm}^{-3} \text{ sr}^{-1} \text{ Hz}^{-1}\text{]}$$

$$j = \int j_\nu d\nu \text{ [erg s}^{-1} \text{ cm}^{-3} \text{ sr}^{-1}\text{]} \text{ **volume emissivity**}$$

For a line emission, assuming  $j_\nu \leftrightarrow (\theta, \varphi)$ ,

$j_\nu$  is governed by a distribution function

$\phi(\nu)$  (**line profile**),

$$\int_0^\infty \phi_\nu d\nu = 1$$

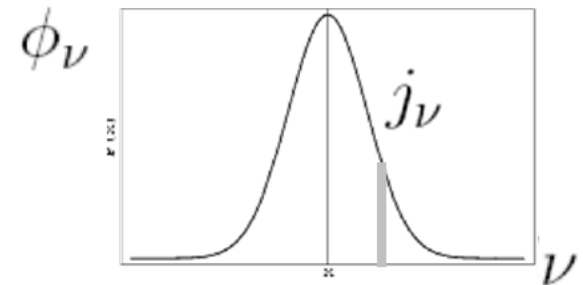

Once an atom is excited, there is a finite probability within  $dt$ ,  $A_{21} dt$  to jump spontaneously from level 2 to level 1 (deexcitation).

The total number of downward transitions  $2 \rightarrow 1$  is  $n_2 A_{21}$ , where  $n_2$  is the number of atoms (population) in level 2 per unit volume.

**$A_{21} [\text{s}^{-1}]$ : Einstein  $A$  coefficient for spontaneous transition  
= probability per unit time**

$1/A_{21} [\text{s}]$ : lifetime staying in level 2 (i.e.,  $e^-$  remaining excited)

$$j_\nu = \frac{h\nu_0}{4\pi} n_2 A_{21} \phi(\nu)$$

# Forbidden Lines

Allowed transitions (via an **electric dipole**) satisfying selection rules

1. Parity change
2.  $\Delta L = 0, \pm 1, L = 0 \rightarrow 0$  forbidden
3.  $\Delta J = 0, \pm 1, J = 0 \rightarrow 0$  forbidden
4. Only one electron with  $\Delta \ell = \pm 1$
5.  $\Delta S = 0$  (Spin not changed)

A forbidden transition is one that fails to fulfill at least one of the selection rules 1 to 4. It may arise from a **magnetic dipole** or an **electric quadrupole** transition.

# Spectroscopic Notation

## Ionization State

I ---- neutral atom, e.g., H I  $\rightarrow$  H<sup>0</sup>

II --- singly ionized atom, e.g., H II  $\rightarrow$  H<sup>+</sup>

III – doubly ionized atom, e.g., O III  $\rightarrow$  O<sup>++</sup>

..... and so on....e.g., Fe XXIII

## Peculiar Spectra

e (emission lines), p (peculiar, affected by magnetic fields),

m (anomalous metal abundances), e.g., B5 Ve

- **Forbidden Lines** (a pair of square brackets), e.g., [O III], [N II]
- **Semi-forbidden Lines** (a single bracket), e.g., [OII]
- **Allowed (regular) Lines** (no bracket), e.g., C IV

Some examples:

Lyman  $\alpha$ ,  $A_{21} \approx 6.25 \times 10^8 \text{ s}^{-1}$

[O III]  $A_{21} = 0.021 \text{ s}^{-1}$ ,  $\lambda_{21} = 5007 \text{ \AA}$   
 $A_{21} = 0.0281 \text{ s}^{-1}$ ,  $\lambda_{21} = 4959 \text{ \AA}$   
 $A_{32} = 1.60 \text{ s}^{-1}$ ,  $\lambda_{32} = 4364 \text{ \AA}$

[S II]  $A_{21} = 4.7 \times 10^{-5} \text{ s}^{-1}$ ,  $\lambda_{21} = 6716 \text{ \AA}$

H I 21 cm hyperfine line  $A_{21} \approx 10^{-15} \text{ s}^{-1}$ , the probability is extremely low.

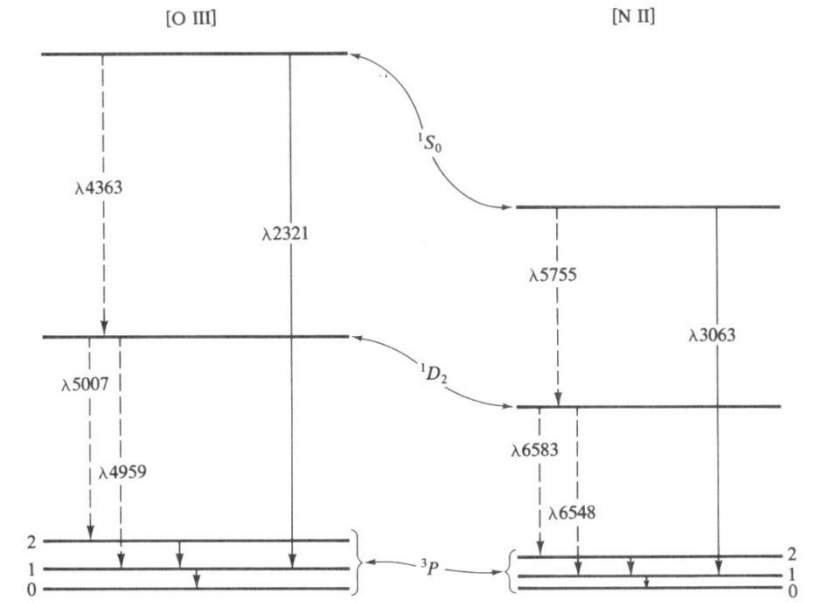

## Derivation of $A_{21}$

The **Poynting vector** (EM flux flow)  $\vec{S} = \frac{c}{4\pi} \vec{E} \times \vec{B}$

An accelerated ( $\ddot{r}$ ) charge  $q$  emits a total power (Larmor formula)

$$\mathbb{P} = \frac{2q^2\ddot{r}^2}{3c^3}$$

- ✓ Power emitted proportional to the square of the charge and square of the acceleration
- ✓ Radiation max perpendicular to acceleration; none along the acceleration
- ✓ Radiation is polarized

$$\frac{d\mathbb{P}}{dV} = n_2 h\nu_{21}A_{21}$$

**$B_{12}I_\nu$**  : The Einstein  $B$  coefficient for absorption transition  
= probability per unit time be excited from level 1  
to 2 by absorption of a photon;  $I_\nu$  is the  
energy density of the radiation field

There is the corresponding Einstein  $B$  coefficient for  
stimulated emission, for which  **$B_{21} I_\nu$**  gives the transition  
probability of the stimulated emission, i.,e., a photon incident  
on an atom on the upper state induces a transition to the  
lower state, producing a new photon of the same frequency,  
before spontaneous transition takes place.

In TE, the number of downward transitions (per unit time per unit volume)  
= the number of upward transitions, i.e.,

$$n_2 A_{21} + n_2 B_{21} I_\nu = n_1 B_{12} I_\nu$$

Solving for  $I_\nu$ ,

$$u_\nu = \frac{4\pi}{c} J_\nu$$

$$I_\nu = \frac{A_{21}/B_{21}}{(n_1/n_2)(B_{12}/B_{21}) - 1}$$

But in TE,  $n_1/n_2$  is governed by Boltzmann equation, so

$$I_\nu = \frac{A_{21}/B_{21}}{(g_1/g_2) \exp(h\nu_0/kT)(B_{12}/B_{21}) - 1}$$

Also in TE,  $I_\nu = B_\nu$  and varies little within  $\Delta\nu$ ,  $\nu \rightarrow \nu_0$



$$I_\nu = B_\nu = \frac{A_{21}/B_{21}}{(g_1/g_2) (B_{12}/B_{21}) \exp(h\nu_0/kT) - 1}$$

Comparing to the Planck function,

$$B_\nu(T) = \frac{2 h \nu^3}{c^2} \frac{1}{\exp(h\nu/kT) - 1}$$

we get

*(exponent must equal to the exponent)*

$$g_1 B_{12} = g_2 B_{21}$$

and

$$A_{21} = \frac{2 h \nu^3}{c^2} B_{21}$$

In fact, these **detailed balance relations** are related to the atomic properties, so should be  $T$  independent, i.e., regardless of TE or not.

$$n_2 A_{21} + n_2 I_\nu B_{21} = n_1 I_\nu B_{12}$$

$$I_\nu (n_1 B_{12} - n_2 B_{21}) = n_2 A_{21}$$

$$I_\nu = \frac{n_2 A_{21}}{n_1 B_{12} - n_2 B_{21}}$$

$$= \frac{A_{21}}{(n_1/n_2) B_{12} - B_{21}} = \frac{A_{21}/B_{21}}{(n_1/n_2) (B_{12}/B_{21}) - 1}$$

$$= \frac{A_{21}/B_{21}}{(g_1/g_2) e^{h\nu_0/kT} (B_{12}/B_{21}) - 1}$$

$${}^{TE} I_\nu \equiv B_\nu = \frac{2h\nu^3}{c^2} \frac{1}{e^{h\nu/kT} - 1}$$

Separating into w/ and w/o  $e^{h\nu/kT}$

$$\frac{1}{e^{h\nu/kT} - 1} = \frac{(A_{21}/B_{21}) \left( \frac{2h\nu^3}{c^2} \right)}{(g_1/g_2) (B_{12}/B_{21}) e^{h\nu/kT} - 1}$$

T-dep term eq T-dep term, ... (exponential)

$$\frac{A_{21}}{B_{21}} \left( \frac{2h\nu^3}{c^2} \right) = 1 \Rightarrow A_{21} = \frac{2h\nu^3}{c^2} B_{12}$$

$$\left( \frac{g_1}{g_2} \right) \left( \frac{B_{12}}{B_{21}} \right) = 1 \Rightarrow g_1 B_{12} = g_2 B_{21}$$

To relate the absorption and emission coefficients and Einstein coefficients, recall

$$j_\nu = \frac{h\nu_0}{4\pi} n_2 A_{21} \phi(\nu)$$

Likewise, for absorption (including stimulated emission --- dependent on the incident intensity)

$$\kappa_\nu = \frac{h\nu_0}{4\pi} \phi(\nu) (n_1 B_{12} - n_2 B_{21})$$

$$\frac{dI_\nu}{ds} = -\kappa_\nu I_\nu + j_\nu$$

So the radiative transfer equation now becomes

$$\frac{dI_\nu}{ds} = -\frac{h\nu}{4\pi} \phi(\nu) (n_1 B_{12} - n_2 B_{21}) I_\nu + \frac{h\nu}{4\pi} n_2 A_{21} \phi(\nu)$$

## Exercise

A star has been measured to have a spectral type of G5V, and an apparent magnitude of  $m_V = 4.84$  mag.

- (1) What are the expected absolute magnitude and bolometric luminosity given the spectral type?
- (2) With these, estimate the distance of this star.
- (3) The star has a Gaia parallax of  $107.80 \pm 0.18$  mas. Compute the distance and the associated error from this measurement.

## Exercise

Sirius has a metallicity of  $[\text{Fe}/\text{H}] = +0.5$  dex.

- (1) What is its metallicity  $Z$ ?
- (2) The star is estimated to be about 200 Myr old. How is this known?